

ESAM CATALOGUE 2026

SPECIALISTS IN AIR TECHNOLOGY

- » Side Channel Blowers
- » Compressed Air

SUPERIOR ITALIAN CRAFTSMANSHIP

ESAM's journey starts in Parma, Italy, a historic hub of Italian excellence. Since 1984, our family-run business has been rooted in the tradition of superior Italian craftsmanship. Known for the 'MADE IN ITALY' mark, ESAM represents the pinnacle of quality in designing and manufacturing side channel blowers and air compressors.

Our products are more than machinery; they are hand-crafted symbols of innovation, distributed globally. Each product is a testament to our deep expertise in air technology, combining reliability and high performance. We embody the spirit of Italian craftsmanship, blending it seamlessly with technical precision to produce robust, revolutionary equipment.

As a leader in air technology, ESAM is distinguished by our meticulous hand-crafted components, ensuring that our quality is both outstanding and measurable. Our commitment goes beyond business; it's about building enduring relationships with customers, rooted in trust and a family legacy of delivering unparalleled excellence.

// All this painstaking care for our work... are justified by the results achieved. Quality needs to be sought with determination and must be scrupulously adhered to thereafter. We cannot afford to stop, as progress is unstoppable. //

Professor Augusto Cattani – Founder.



Parma, Italy

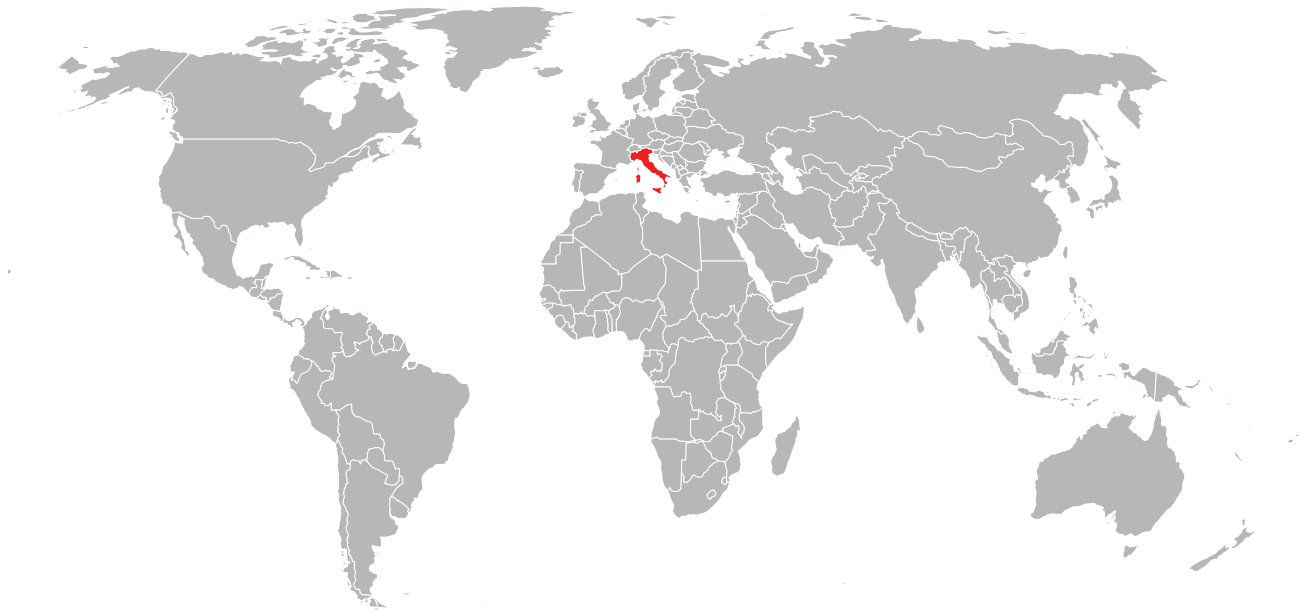

QUALITY COMES FIRST

Our success has been built upon a reputation for specialisation in air technology. Across generations our legacy has been one of technical advancement and a commitment to our customers and their reputations. From Italy to the world, we speak the same language - quality.

Your advantage is our specialisation

The movement of air is our speciality, it has been for more than 40 years. Utilising our entrepreneurial spirit, world-class engineers and a commitment to best-in-class reliability we have innovated and learnt a lot. Best of all this knowledge is imparted through our online and face-to-face training.



Hand-built in Italy

ESAM relies on premium quality materials and the unique technical skill set of our trained technicians. High-quality workmanship and an attention to the finer details, can only come from a combination of passion for air technology, commitment to quality and assembling every side channel blower by hand. The result is a low vibration, low noise, and reliable operation.



Quality Accreditation

Products are designed and manufactured with quality as key differentiator. ESAM S.p.A is certified under UNI EN ISO 9001:2015.



Individually Tested

At ESAM, there is no such thing as 'batch testing'; we rigorously test every unit, putting every blower through all the extreme conditions under which it is likely to operate. We stand by our commitment to quality comes first and each units serial number can be individually checked for system testing results.



Certified cCSAus Models

The electric motors of selected blowers are certified cCSAus. This mark, given by MOU agreement between UL and CSA, certify the complete motor. Also our test facilities at ESAM S.p.A have been recognised as a CSA laboratory.

QUALITY COMES FIRST.



EXPLORING AIR AND SPACE

Partnerships are built on trust, and reputation is the cornerstone of success. Our success comes from a commitment to research, innovation, and an unwavering focus on quality within our speciality – air technology.

The NASA Space Shuttle project is an affirmation to the Cattani-ESAM Group's reputation for air technology. When a compressed air solution was required for the NASA Space Shuttle, we met the challenge head on and developed a compact 38 Bar pressure compressor.

TABLE OF CONTENTS

SIDE CHANNEL BLOWERS	PAGE
Performance Graphs	10
Performance Chart	11
Three Phase Systems	13
Single Phase Systems	43
Accessories	52
Installation	53

COMPRESSORS	PAGE
5 Bar Compressors	58
5 Bar Quiet Compressors	78
8 Bar Compressors	91
8 Bar Quiet Compressors	97
Accessories	102

APPENDIX	PAGE
Special Order Models	105
IE3 Range	106
Useful Information	107



ESAM Australia offers a 5-year warranty from the date of purchase of our side channel blowers and compressors in Australia and New Zealand. For all other ESAM products there is a 1-year warranty from the date of purchase. For full terms and conditions our warranty statement can be downloaded from our website.

TERMS & CONDITIONS

Product selection is provided as a guide only. To determine the requirements of your applications please contact our ESAM Technical Services Team. ESAM Australia has a commitment to innovation and continuous improvements and as such we reserve the right to change product specifications without notice. Please refer to our website for the most current product specifications. Some items listed are "indent only" products and are subject to our "Forward Order and Indent Item Policy." Please contact your ESAM Business Development Manager or our Customer Service Team for further information.
 © 2026. ESAM Australia Pty Ltd. All rights reserved.

// We're committed to eco-friendly innovation
not as a choice, but as a responsibility to our
global family. //

Greg Fox - ESAM Australia CEO

“SOSTENIBILITÀ PER LA NOSTRA FAMIGLIA GLOBALE” SUSTAINABILITY FOR OUR GLOBAL FAMILY

As a family-owned business we understand the importance of leaving this world better for the next generation. ESAM integrates sustainable initiatives across our business from using recycled materials where possible, being 100% Carbon Neutral in our Australian operation to having a focus on minimising raw materials in our products just to name a few.



100% Carbon Neutral - ESAM Australia

As part of our commitment to sustainability, ESAM Australia as part of the Australian group has gone 100% Carbon Neutral in our operations since 2023 through our partner TRACE.



Raw Material Selection and Reduction

ESAM manufacturing in Italy has a continuous improvement process of actively reducing raw material usage of their systems. This design concept is all encompassing and is multi-faceted from using recyclable materials where possible, improving product energy efficiency and performance, changing to readily recyclable plastics where possible.



100% Recycled Aluminium Side Channel Blowers

Our side channel blowers are manufactured using only recycled Aluminium. As part of ESAM Italy's raw material manufacturing strategy we are committed to using recycled materials and materials that can be recycled at end-of-life.

REPUTATION MATTERS, ESPECIALLY YOURS









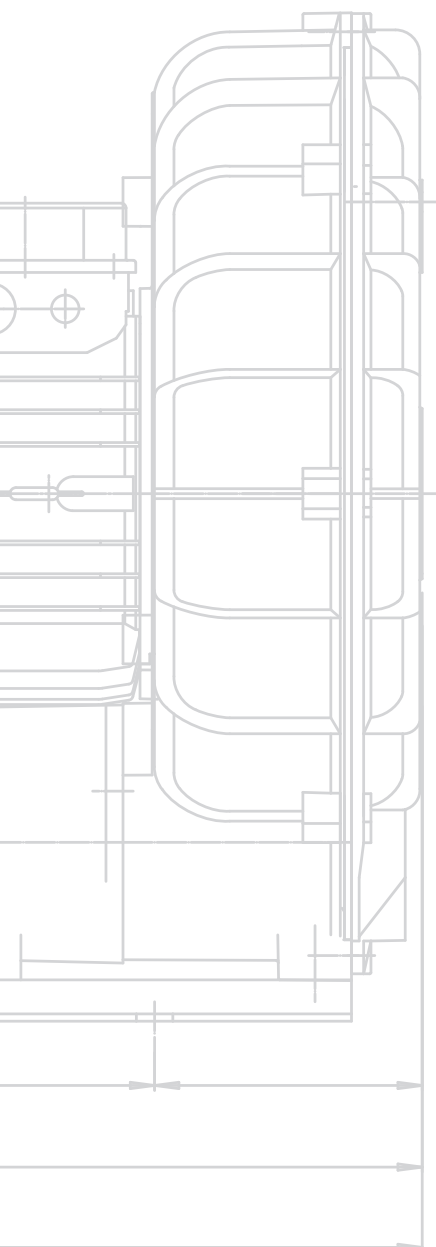











As a family-owned business we understand the importance of reputation, after all, just like you we have invested our time in building it. Over the generations it has been our commitment to research, an unwavering dedication to improved performance, an uncompromising focus on high-quality materials and workmanship, that has led us to be recognised as leaders in our field. It is the underlying promise of premium quality that our reputation is built upon, and as such our commitment to our customers that trust their reputation in us.

Success across industries

ESAM's commitment to reliability and quality is recognised across numerous industries. When reliability is integral to success, select ESAM as your partner in air technology.

Quality comes first, because your reputation depends on it.



- | | | |
|---|--|---|
|  |  |  |
| AGRICULTURE | ELECTRONIC | MANUFACTURING |
|  |  |  |
| AQUACULTURE | ENERGY | MEDICAL |
|  |  |  |
| AQUATICS | FOOD & BEVERAGE | METAL WORK |
|  |  |  |
| AUTOMOTIVE | GLASS | PACKAGING |
|  |  |  |
| CHEMICAL & PHARMACEUTICAL | GOVERNMENT & INFRASTRUCTURE | RETAIL |
|  |  |  |
| CLEANING | GRAPHICS | TEXTILE |
|  |  |  |
| CONSTRUCTION | LABORATORY | WATER & ENVIRONMENT |

AS UNIQUE AS YOUR BUSINESS

ESAM understands that every business is unique and that it is not a one solution fits all. ESAM is able to provide custom solutions to meet your air technology requirements. Our in-house technical support team will work closely with you along side our colleagues in Italy to provide a compressed air solution or side channel blower design to meet your specific needs. Customers worldwide have approached ESAM with their air technology challenges. It is with great pride that we are able to solve them with air technology solutions. This invitation is extended to you.

Project solutions: As easy as 1,2,3.

- 1 Consultation**
 Discuss the key air technology requirements and objectives that need to be met for the project.
- 2 Recommendation**
 Review your requirements in line with product range and required custom modifications. Advise on optimal solution.
- 3 Production**
 Once approved by customer, production will commence in line with deliverable timeline.

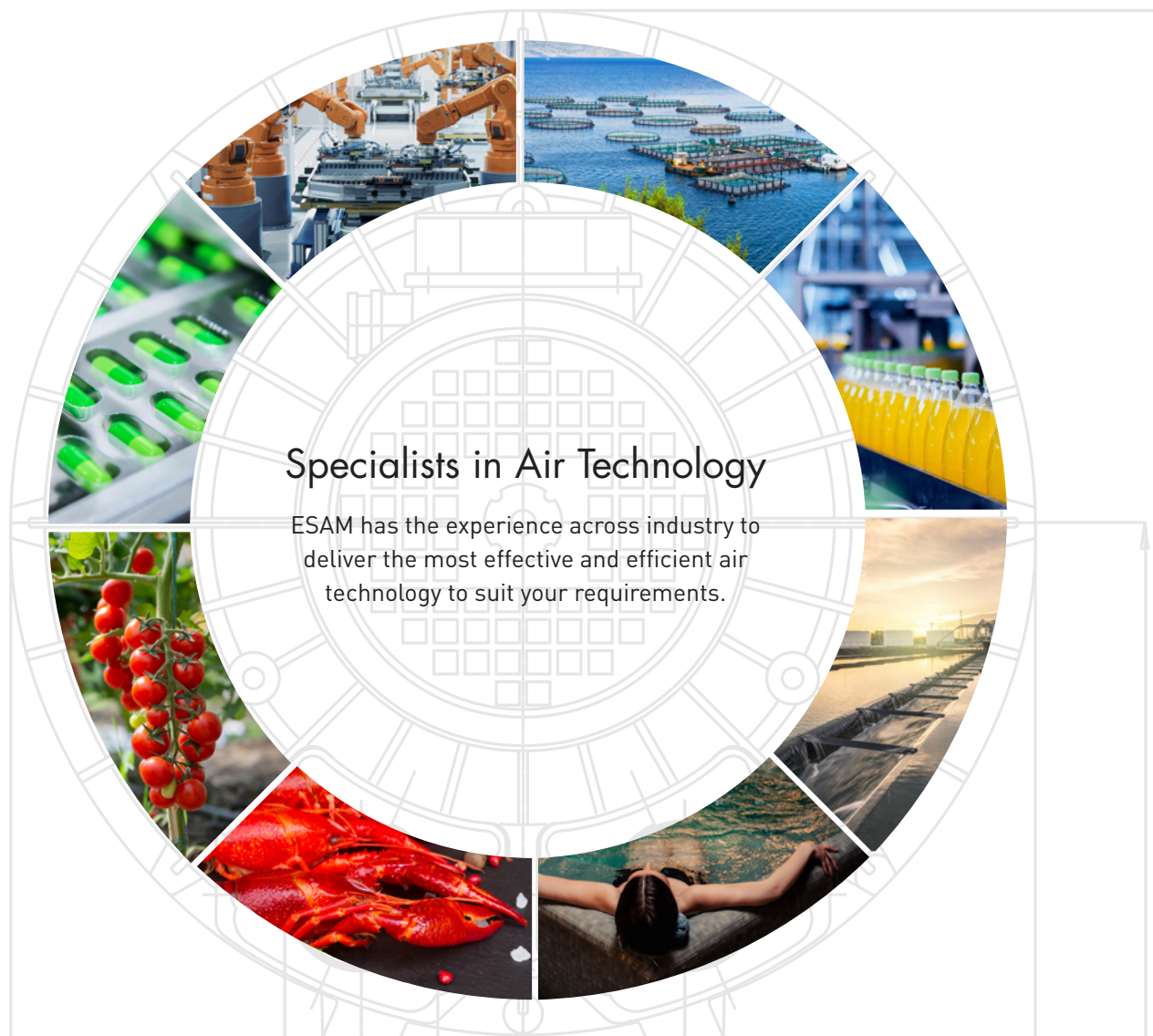

PERFORMANCE GRAPHS

+ Indent Only ‡ POA/INDENT ● Two Stage Blower - Greater Pressure ● Two Stage Blower - Greater Volume

PRESSURE PERFORMANCE GRAPH

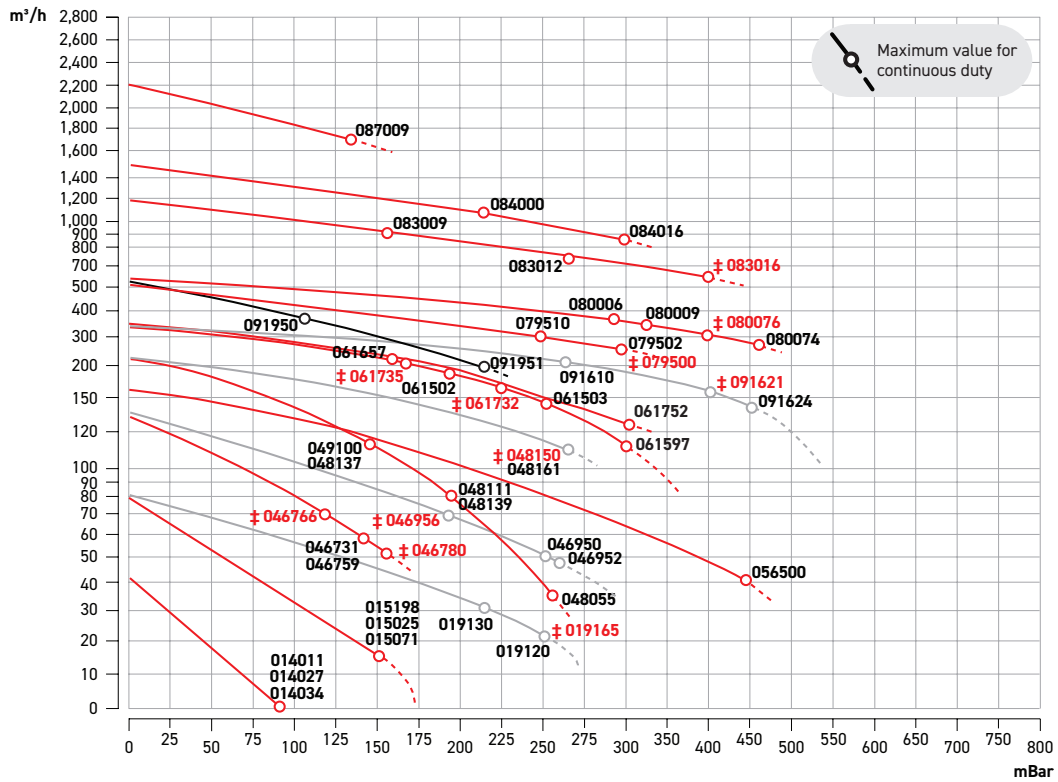

VACUUM PERFORMANCE GRAPH

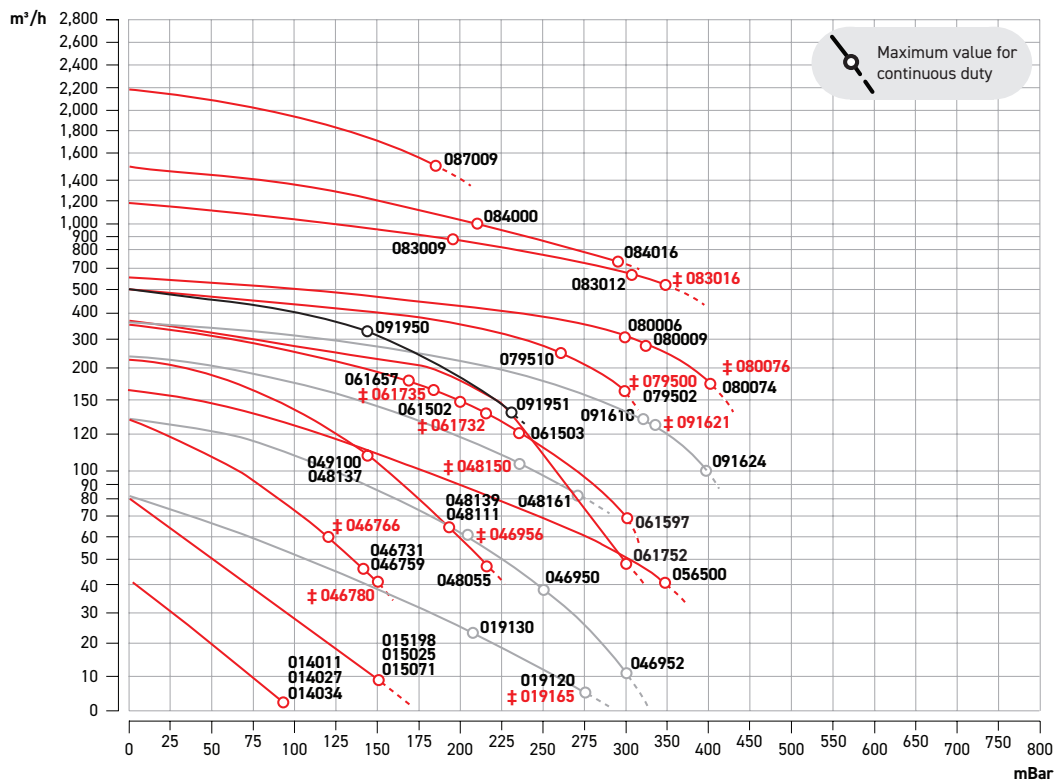

IMPORTANT INFORMATION

VALUES & DATA: The pressure and flow rates have a tolerance of ± 10%. The vacuum curves are valid for pumping air, with a temperature of 20°C at the inlet flange and with a pressure of 1013 mBar at the discharge port. The pressure curves are valid for pumping air, with an average temperature of 20°C, a density of 1.23 kg/m³ and 1013 mbar at the inlet flange. All data is intended as an indication of product specification. Due to our programme of continuous improvement, we reserve the right to change pictorial, performance and dimensional data without prior notice. Sound pressure data in accordance to ISO 3746-1979 [E] norms. Parameters: r = 1 - background noise ≤ 51 dB(A) - instrument used: Bruel & Kjaer. **MEDIUM OF AIR:** The standard side channel blowers are designed to pump clean air up to a maximum of 40°C. **INVERTER COMPATIBILITY:** When an inverter (frequency converter) is to be used with an ESAM Side Channel Blower it is the **INSTALLERS RESPONSIBILITY** to ensure that they adhere to all respective laws and standards and contact ESAM to ensure product suitability prior to installation.

PERFORMANCE CHART

+ Indent Only ‡ POA/INDENT ● Two Stage Blower - Greater Pressure ● Two Stage Blower - Greater Volume

THREE PHASE SIDE CHANNEL BLOWERS

kW	Item Code	Item Description	Δ Delta Volt	Δ Delta Amp	Y Star Volt	Y Star Amp	Max. Air Flow m ³ /hr*	Max. Pressure mBar*	Max. Vacuum mBar*	Order	Page
0.2	014034	UNI-JET 40	200-240	1.5	345-415	0.85	40	+ 90	-90	+	14
0.4	015071	UNI-JET 75	200-240	2.3	345-415	1.35	80	+145	-145		15
● 0.75	019130	UNI-JET 75 2V	200-240	3.4	345-415	1.95	80	+215	-215		16
● 0.75	019165	UNI-JET 75 2V	230	3.4	400	1.95	80	+270	-245	‡	16
0.75	046766	TECNO-JET	200-240	4.7	345-415	2.7	135	+120	-120	‡	17
0.75	046731	TECNO-JET II/s	220-240	4.2	345-415	2.4	135	+140	-145		17
1.1	046780	TECNO-JET	200-240	5.2	345-415	3	135	+155	-155	‡	17
1.1	049100	FLUX-JET 80	200-240	5.2	345-415	3	200	+145	-145		18
● 1.5	046950	TECNO-JET 2V	200-240	7.1	345-415	4.1	135	+245	-245	‡	19
● 1.5	046952	TECNO-JET 2V LHT	200-240	7.1	345-415	4.1	135	+255	-295		19
1.5	048111	FLUX-JET 1.5	200-240	6.9	345-415	4	200	+185	-185		20
2.2	048055	FLUX-JET 2.2	230	9	400	5.2	200	+265	-215	‡	21
● 2.2	048150	FLUX-JET 2V	230	9	400	5.2	200	+265	-230	‡	22
● 2.2	048161	FLUX-JET 2V LHT	230	9	400	5.2	200	+265	-265		22
2.2	061502	MEDIO-JET 2.2	230	9	400	5.2	330	+185	-195		23
2.2	061735	MEDIO-JET 2.2	200-240	10.5	345-415	6	330	+165	-185	‡	23
2.55	061732	MEDIO-JET 2.55	200-240	11.2	345-415	6.5	330	+220	-215	‡	23
3	061503	MEDIO-JET 3	230	11.8	400	6.8	330	+245	-230		24
4	056500	UNI-JET 160	200-240	16.7	345-415	9.7	160	+440	-345		26
4	061752	MEDIO-JET 350	200-240	16.7	345-415	9.7	370	+290	-300		27
4	061597	MEDIO-JET LHT	200-240	16.7	345-415	9.7	330	+295	-295		29
● 4	091610	MEDIO-JET 2V	200-240	16.7	345-415	9.7	330	+260	-315	+	28
● 4	091950	MEDIO-JET 1AC 4	200-240	16.7	345-415	9.7	500	+105	-135		30
● 5.5	091621	MEDIO-JET 2V	200-240	22.5	345-415	13	330	+390	-320	‡	28
● 5.5	091624	MEDIO-JET 2V LHT	200-240	22.5	345-415	13	330	+440	-390		25
● 5.5	091951	MEDIO-JET 1AC 5.5	200-240	22.5	345-415	13	500	+215	-225		31
5.5	079510	UNI-JET 501 5.5	200-240	22.5	345-415	13	500	+245	-255	+	32
7.5	079500	UNI-JET 501 7.5	345-415	17.3	220-240	30	500	+285	-295	+	33
7.5	079502	UNI-JET 501 7.5	345-415	17.8	690	10.28	500	+285	-295	+	33
7.5	080006	UNI-JET 500 7.5	345-415	17.8	690	10.28	600	+285	-295		34
9	080009	UNI-JET 500 9	345-415	22.3	690	12.88	600	+320	-315	+	35
11	080076	UNI-JET 500 11	345-415	24.2	690	13.97	600	+400	-390	‡	36
11	083009	UNI-JET 1000 11	345-415	25	690	14.43	1200	+155	-185	+	37
12.5	080074	UNI-JET 500 12.5	345-415	26.8	690	15.47	600	+465	-390		36
15	083012	UNI-JET 1000 15	345-415	33.2	690	19.17	1200	+265	-315	+	38
15	084000	UNI-JET 1500 15	345-415	33.2	690	19.17	1500	+210	-225	+	40
20	083016	UNI-JET 1000 20	345-415	44.3	690	25.58	1200	+390	-345	+	39
20	084016	UNI-JET 1500 20	345-415	44.3	690	25.58	1500	+295	-295	+	41
20	087009	UNI-JET 2200	345-415	44.3	690	25.58	2200	+130	-185	+	42

SINGLE PHASE SIDE CHANNEL BLOWERS

kW	Item Code	Item Description	Volt	Amp	Max. Air Flow m ³ /hr*	Max. Pressure mBar*	Max. Vacuum mBar*	Order	Page
0.2	014011	UNI-JET 40 SP	230	2	40	+90	-80		44
0.4	015025	UNI-JET 75	230	3.1	80	+145	-145		45
0.4	015198	UNI-JET 75 CCSAUS	230	6-3 (50Hz)	80	+147	-147		46
0.75	046759	TECNO-JET II/s	230	5.5	135	+135	-135		47
● 0.8	019120	UNI-JET 75 2V	230	4.8	80	+245	-270		48
1.1	048137	FLUX-JET 1.1	230	7.6	200	+145	-145		49
1.5	048139	FLUX-JET 1.5	230	10	200	+185	-185		50
2	061657	MEDIO-JET CE	240	12	330	+160	-170		51

HOW IT WORKS

- 1 Air enters the side channel blower through the inlet port and into the rotating impeller
- 2 The air particles are pushed in the direction of the impeller rotation
- 3 Centrifugal force created by the accelerating turbine blades pushes the air outward and the pressure increases
- 4 With every rotation kinetic energy is added and converted into pressure
- 5 Compressed air leaves the impeller blades and is conveyed through the discharge port

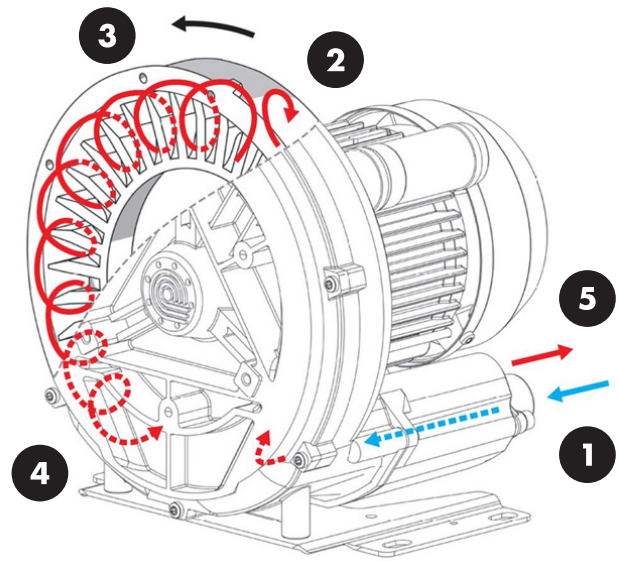

Need more air-flow?

Two Stage "1AC" motors combine the airflow in parallel to generate increased airflow.

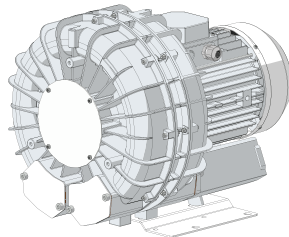

Need more pressure?

Two Stage "2V" motors combine the airflow in series generate increased pressure.

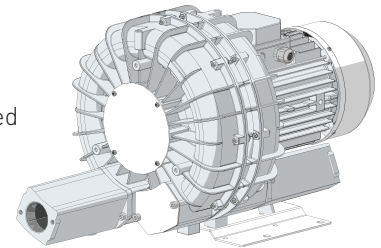

Teflon® or anodised protection options

ESAM has the option of anodising or Teflon® coating our side channel blowers when additional corrosion protection is required. Contact ESAM for lead times and pricing.

Small tolerances, big performance.

The tolerance between the turbine and the housings is extremely small (tenths of a millimetre in some blowers), which in conjunction with the vortex shape impellers create very strong pressure. ESAM blade design and precisely engineered toroidal channel housing help achieve efficiency gains.

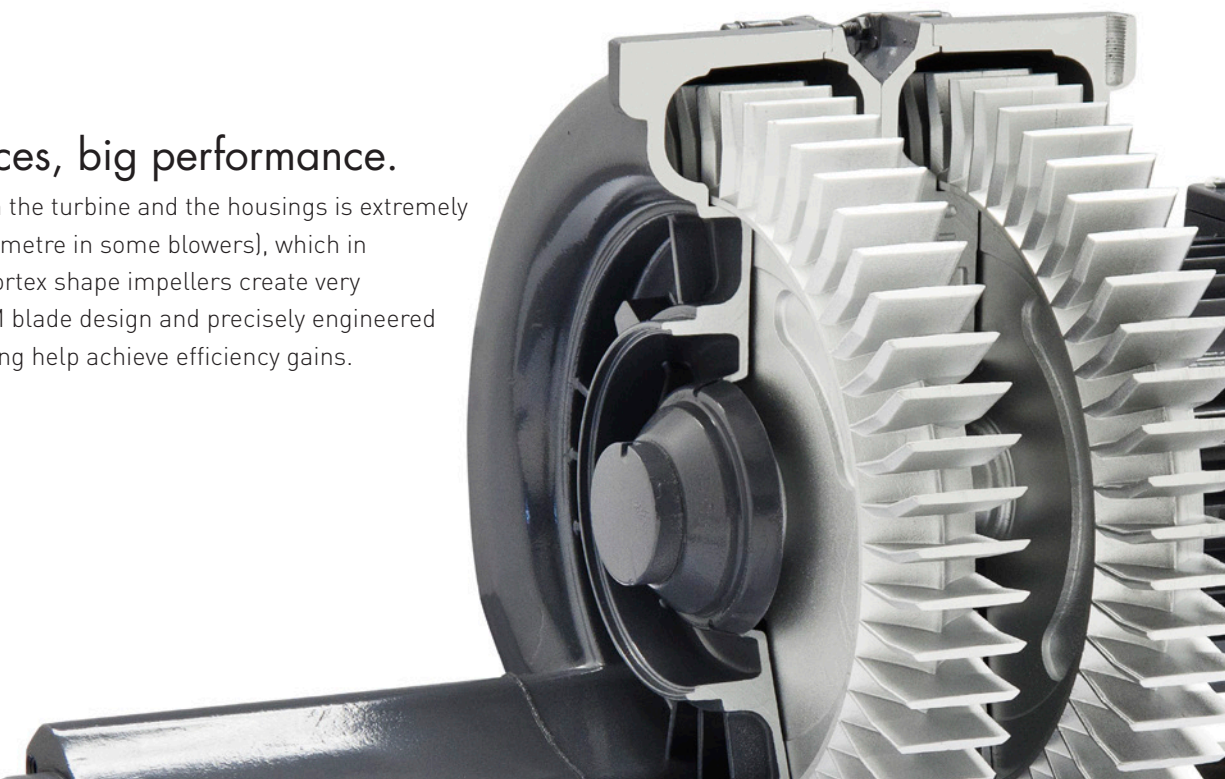

THREE PHASE

SIDE CHANNEL BLOWERS



ESAM's three-phase side channel blowers, designed for excellence, are the foundation of successful operations. These models, notable for their efficiency and performance, excel in continuous heavy-duty tasks. Their robust build and advanced technology, enhanced by inverter compatibility, ensure uninterrupted, powerful airflow for diverse applications such as vacuum lifting and pneumatic conveying. Engineered for the industrial arena, they are reliable partners, propelling your projects to new heights.

UNI-JET 40

3PH SIDE CHANNEL BLOWER

The UNI-JET 40 is the smallest of the ESAM UNI-JET series of side channel blowers that delivers a maximum air flow of 40 m³/hr and a maximum of pressure of +90 mBar and maximum vacuum of -90 mBar.

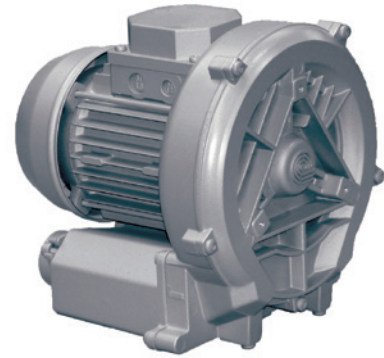

DETAILS THAT MATTER

- » Dynamically balanced
- » Quiet operation
- » Continuous operation 24/7



TECHNICAL DATA											UNI-JET 40			
Item Code	kW	Δ Delta Volt	Δ Delta Amp	Y Star Volt	Y Star Amp	Max. Air Flow m ³ /hr*	Max. Pressure mBar*	Max. Vacuum mBar*	Sound dB(A)	Height	Width	Depth	Weight Kg	Inlet & Outlet
014034	0.2	200-240	1.5	345-415	0.85	40	+90	-90	57	319	302.5	302	7	1"

PRESSURE PERFORMANCE GRAPH

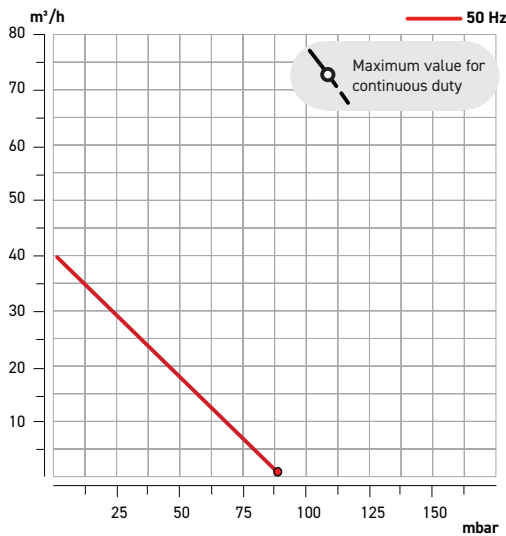

VACUUM PERFORMANCE GRAPH

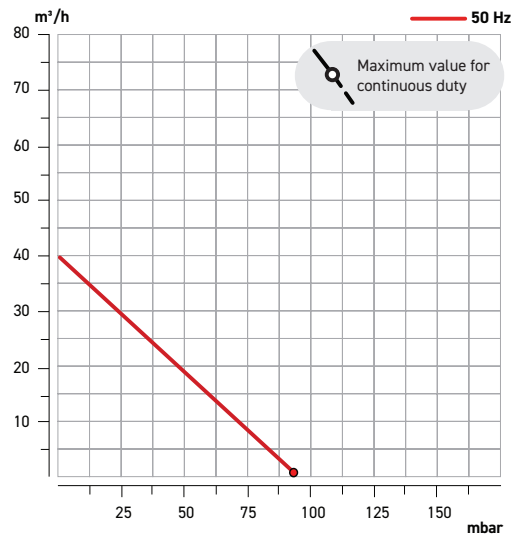

PRESSURE ACCESSORIES

168554	1" Mesh Inlet Filter
168410	1" Complete Inlet Filter
168530S	1" Complete Inlet Filter with Silencer
167690	1" & 1/4" Polyester Cartridge Filter for 168410

VACUUM ACCESSORIES

168410	1" Complete Inlet Filter
167690	1" & 1/4" Polyester Cartridge Filter for 168410

ACCESSORIES - OTHER

169752C	1" Threaded Flange Kit	1610880	Pressure Gauge 100 KPA/PS
---------	------------------------	---------	---------------------------

SERVICE KIT

Upon Request

UNI-JET 75

3PH SIDE CHANNEL BLOWER

One of the most popular side channel blowers from ESAM the Uni-Jet 75 is commonly used for aquatic applications due to its reliable performance.



DETAILS THAT MATTER

- » Commonly used in aquatic applications
- » Robust construction
- » Dynamically balanced



TECHNICAL DATA													UNI-JET 75	
Item Code	kW	Δ Delta Volt	Δ Delta Amp	Y Star Volt	Y Star Amp	Max. Air Flow m ³ /hr*	Max. Pressure mBar*	Max. Vacuum mBar*	Sound dB(A)	Height	Width	Depth	Weight Kg	Inlet & Outlet
015071	0.4	200-240	2.3	345-415	1.35	80	+145	-145	62	251	245.5	231	10	1¼"

PRESSURE PERFORMANCE GRAPH

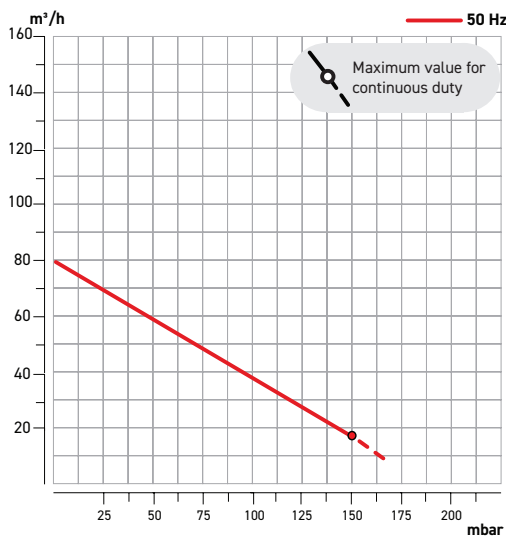

VACUUM PERFORMANCE GRAPH

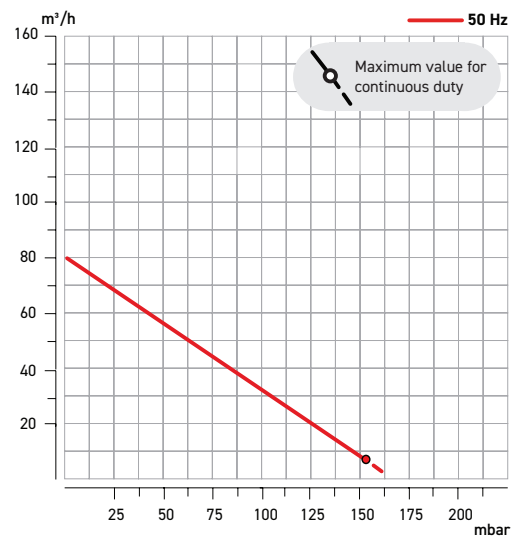

PRESSURE ACCESSORIES

169886	1½" Pressure Relief Valve
168550	1¼" Mesh Inlet Filter
168411	1¼" Complete Inlet Filter
168552S	1¼" Complete Inlet Filter with Silencer
167690	1" & 1¼" Cartridge Filter for 168410 & 168411
167682	1¼" & 1½" Cartridge Filter for 168552S, 168554S and 168412L

VACUUM ACCESSORIES

169885	1½" Vacuum Relief Valve
168560	1¼" Complete Vacuum Filter
167671	1¼" Replacement Cartridge for 168560

ACCESSORIES - OTHER

169411	1¼" Barrel Silencer (Threaded Single End)	169750C	1¼" Threaded Flange Kit
169384	1¼" Barrel Silencer (Threaded Double End)	1610880	Pressure Gauge 100 KPA/PS

SERVICE KIT

UNISK3	Uni-Jet 75 3 Phase - 5 Year Service Kit
--------	---

UNI-JET 75 2V

3PH SIDE CHANNEL BLOWER

When greater pressure is required the 2-stage Uni-Jet 75 2V is the ideal choice. Delivering a maximum pressure of +215 mBar.



DETAILS THAT MATTER

- » Robust design
- » Reliable operation

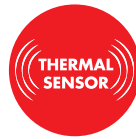

TECHNICAL DATA											UNI-JET 75 2V			
Item Code	kW	Δ Delta Volt	Δ Delta Amp	Y Star Volt	Y Star Amp	Max. Air Flow m ³ /hr*	Max. Pressure mBar*	Max. Vacuum mBar*	Sound dB(A)	Height	Width	Depth	Weight Kg	Inlet & Outlet
019130	0.75	200-240	3.4	345-415	1.95	80	+215	-215	64	251	245.5	489	16	1¼"

PRESSURE PERFORMANCE GRAPH

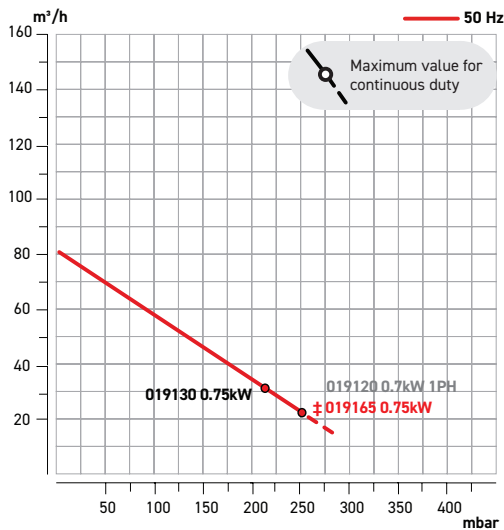

VACUUM PERFORMANCE GRAPH

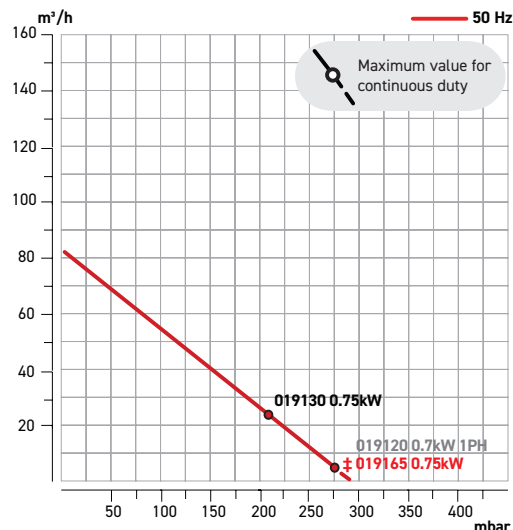

‡ POA/INDEPEND

PRESSURE ACCESSORIES

169886	1½"	Pressure Relief Valve
168411	1¼"	Complete Inlet Filter
168552S	1¼"	Complete Inlet Filter with Silencer
167682	1¼" & 1½"	Polyester Cartridge Filter for 168552S, 168554S and 168412L
167690	1" & 1¼"	Polyester Cartridge Filter (168410 & 168411)

VACUUM ACCESSORIES

169885	1½"	Vacuum Relief Valve
168560	1¼"	Complete Vacuum Filter
167671	1¼"	Replacement Cartridge for 168560

ACCESSORIES - OTHER

169411	1¼"	Barrel Silencer (Threaded Single End)	169750C	1¼"	Uni-Jet 75 & 75 2V Threaded Flange Kit
169384	1¼"	Barrel Silencer (Threaded in/out)	1610880		Pressure Gauge 100 KPA/PS

SERVICE KITS

UNI2VSK3	Uni-Jet 75 2V 3 Phase Service Kit				
----------	-----------------------------------	--	--	--	--

TECNO JET II/S

3PH SIDE CHANNEL BLOWER

The Tecno-Jet II/s side channel blower delivers a maximum pressure of +140 mBar or a maximum vacuum of -145 mBar. Designed for continuous operation the Tecno-Jet II/s is an ideal choice where reliability is critical.

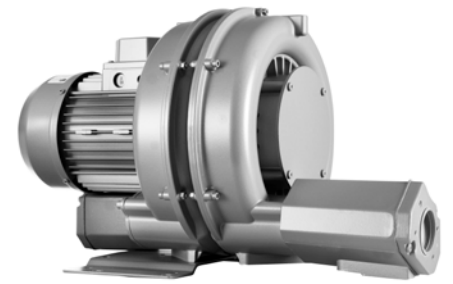

DETAILS THAT MATTER

- » Low noise
- » Reliable operation
- » Low maintenance



TECHNICAL DATA

TECNO-JET II/S

Item Code	kW	Δ Delta Volt	Δ Delta Amp	Y Star Volt	Y Star Amp	Max. Air Flow m ³ /hr*	Max. Pressure mBar*	Max. Vacuum mBar*	Sound dB(A)	Height	Width	Depth	Weight Kg	Inlet & Outlet
046731	0.75	220-240	4.2	345-415	2.4	135	+140	-145	68	251	245.5	302.5	18	1½"

PRESSURE PERFORMANCE GRAPH

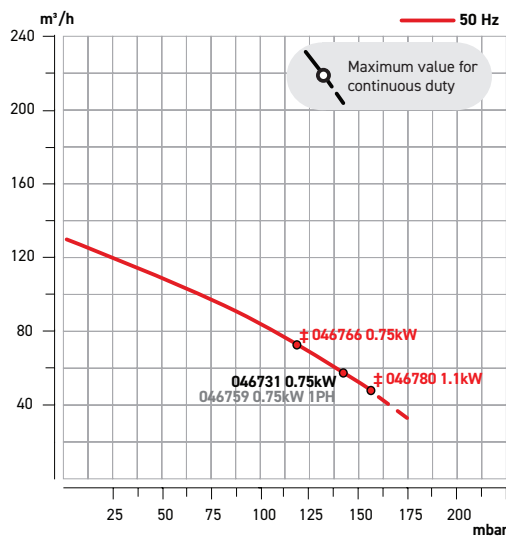

VACUUM PERFORMANCE GRAPH

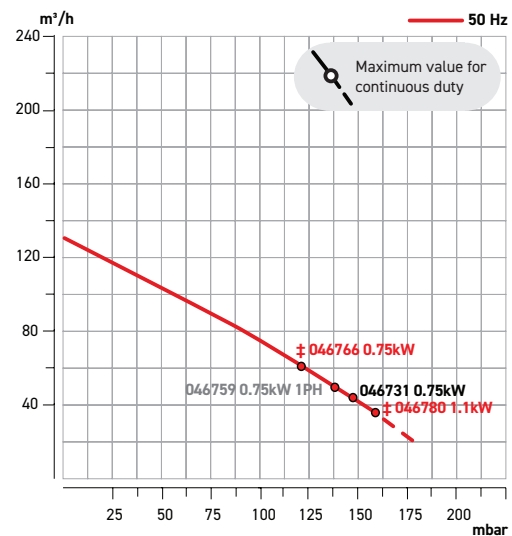

‡ POA/INDEnt

PRESSURE ACCESSORIES

169886	1½" Pressure Relief Valve
168553	1½" Mesh Inlet Filter
168412	1½" Complete Inlet Filter
167682	1¼" & 1½" Polyester Cartridge Filter for 168552S, 168554S and 168412L
167691	1½" Polyester Cartridge Filter for 168412
168554S	1½" Complete Inlet Filter with Silencer

VACUUM ACCESSORIES

169885	1½" Vacuum Relief Valve
168564	1½" Complete Vacuum Filter
167673	1½" Replacement Cartridge for 168564

ACCESSORIES - OTHER

169410	1½" Barrel Silencer (Threaded Single End)	1610880	Pressure Gauge 100 KPA/PS
169385	1½" Barrel Silencer (Threaded in/out)		

SERVICE KITS

TECSK3	Tecno-Jet 3 Phase - 5 Year Service Kit
--------	--

FLUX-JET 80

3PH SIDE CHANNEL BLOWER

Perfectly suited for the pool and spa industry the Flux-Jet 80 is a regularly used for delivering consistent air for spa systems. At only 68dB(A) the side channel blower operates as quietly as standard office noise.



DETAILS THAT MATTER

» Quiet operation



TECHNICAL DATA											FLUX-JET 80			
Item Code	kW	Δ Delta Volt	Δ Delta Amp	Y Star Volt	Y Star Amp	Max. Air Flow m ³ /hr*	Max. Pressure mBar*	Max. Vacuum mBar*	Sound dB(A)	Height	Width	Depth	Weight Kg	Inlet & Outlet
049100	1.1	200-240	5.2	345-415	3	200	+145	-145	68	341	334	294	19	1½"

PRESSURE PERFORMANCE GRAPH

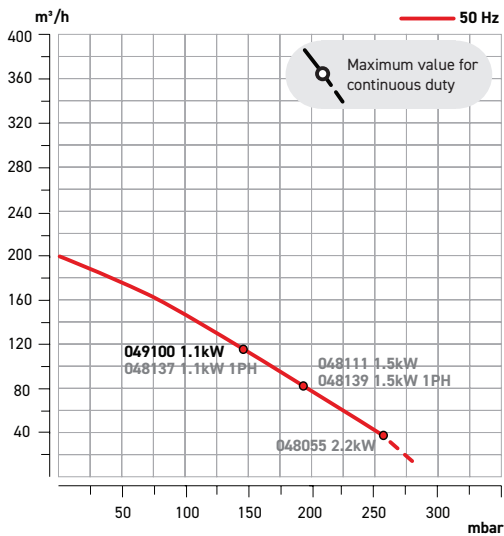

VACUUM PERFORMANCE GRAPH

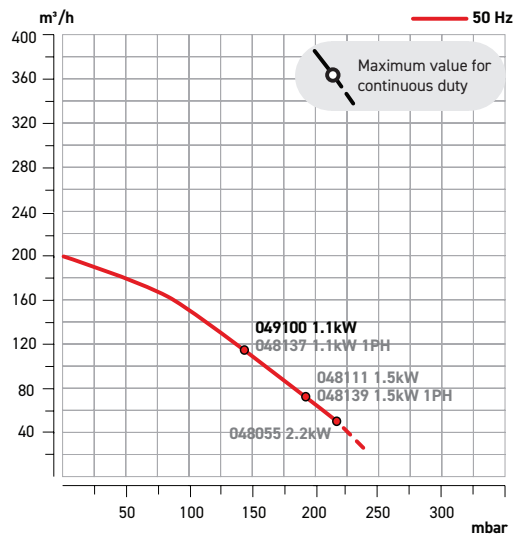

PRESSURE ACCESSORIES

169886	1½" Pressure Relief Valve
168553	1½" Mesh Inlet Filter
168412	1½" Complete Inlet Filter
168554S	1½" Complete Inlet Filter with Silencer
167682	1¼" & 1½" Polyester Inlet Filter for 168552S, 168554S and 168412L
167691	1½" Polyester Cartridge Filter for 168412

VACUUM ACCESSORIES

169885	1½" Vacuum Relief Valve
168564	1½" Complete Vacuum Filter
167673	1½" Replacement Cartridge for 168564

ACCESSORIES - OTHER

169410	1½" Barrel Silencer (Threaded Single End)	1610880	Pressure Gauge 100 KPA/PS
169385	1½" Barrel Silencer (Threaded in/out)		
169770C	1½" Threaded Flange Kit		

SERVICE KITS

FLUSK3	Flux-Jet 3 Phase - 5 Year Service Kit
--------	---------------------------------------

TECNO-JET 2V LHT

3PH SIDE CHANNEL BLOWER

The ESAM range of two-stage blowers deliver greater pressure. The Tecno-Jet 2V LHT is often used in water treatment and aquaculture applications. In addition, the LHT models from ESAM include heat resistant bearings.

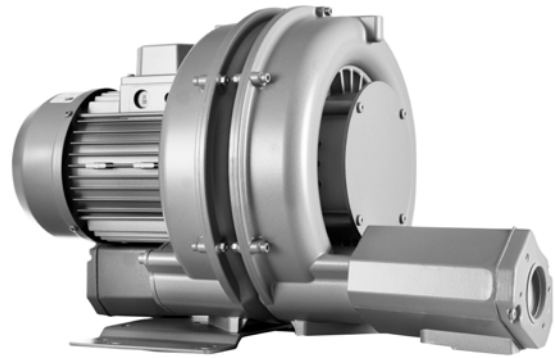

DETAILS THAT MATTER

» Heat resistant bearings



TECHNICAL DATA							TECNO-JET 2V LHT							
Item Code	kW	Δ Delta Volt	Δ Delta Amp	Y Star Volt	Y Star Amp	Max. Air Flow m ³ /hr*	Max. Pressure mBar*	Max. Vacuum mBar*	Sound dB(A)	Height	Width	Depth	Weight Kg	Inlet & Outlet
046952	1.5	200-240	7.1	345-415	4.1	135	+255	-295	65	319	302.5	543	25	1½"

PRESSURE PERFORMANCE GRAPH

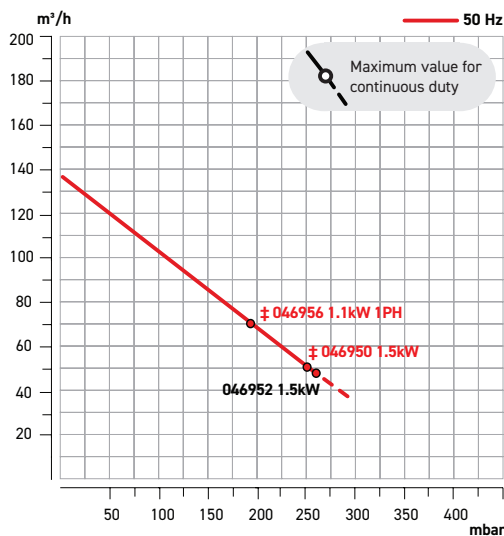

VACUUM PERFORMANCE GRAPH

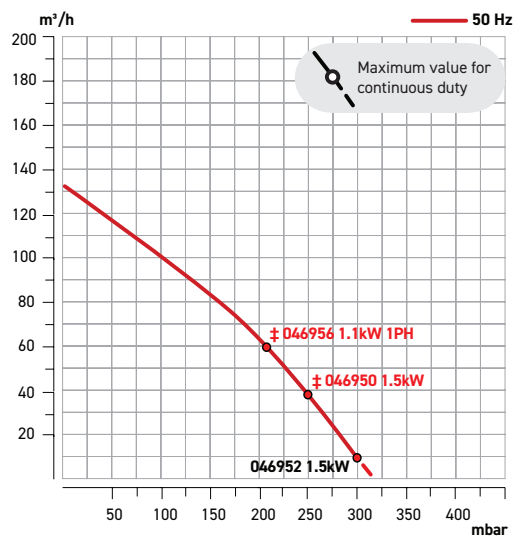

‡ POA/INDEPEND

PRESSURE ACCESSORIES

169886	1½" Pressure Relief Valve
168553	1½" Mesh Inlet Filter
168412	1½" Complete Inlet Filter
168554S	1½" Complete Inlet Filter with Silencer
167691	1½" Polyester Cartridge Filter for 168412
167682	1¼" & 1½" Polyester Cartridge Filter for 168552S, 168554S & 168412L

VACUUM ACCESSORIES

169885	1½" Vacuum Relief Valve
168564	1½" Complete Vacuum Filter
167673	1½" Replacement Cartridge for 168564

ACCESSORIES - OTHER

169410	11½" Barrel Silencer (Threaded Single End)	1610880	Pressure Gauge 100 KPA/PS
169385	1½" Barrel Silencer (Threaded in/out)		

SERVICE KITS

TEC2VLSK1	Tecno-Jet 2V LHT 1.5kW Service Kit
-----------	------------------------------------

FLUX-JET 1.5

3PH SIDE CHANNEL BLOWER

Recognised as one of the flagship of aquaculture, aquatic and water treatment side channel blowers from ESAM, the Flux-Jet 1.5 is often the go to product for reliable performance.



DETAILS THAT MATTER

- » Low maintenance
- » Robust design
- » Anodised version (via special order)

5 YEARS WARRANTY

LOW NOISE & VIBRATION

IP55

MADE IN ITALY

24 CONTINUOUS DUTY RATED 7

THERMAL SENSOR

INVERTER COMPATIBLE

TECHNICAL DATA											FLUX-JET 1.5			
Item Code	kW	Δ Delta Volt	Δ Delta Amp	Y Star Volt	Y Star Amp	Max. Air Flow m ³ /hr*	Max. Pressure mBar*	Max. Vacuum mBar*	Sound dB(A)	Height	Width	Depth	Weight Kg	Inlet & Outlet
048111	1.5	200-240	6.9	345-415	4	200	+185	-185	68	341	334	294	21	1½"

PRESSURE PERFORMANCE GRAPH

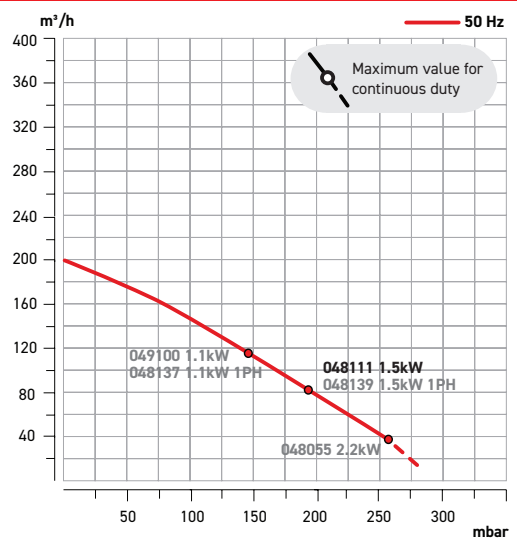

VACUUM PERFORMANCE GRAPH

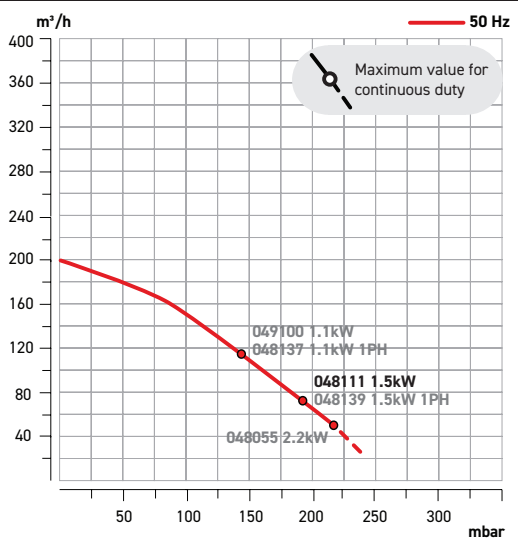

PRESSURE ACCESSORIES

169886	1½" Pressure Relief Valve
168553	1½" Mesh Inlet Filter
168412	1½" Complete Inlet Filter
168554S	1½" Complete Inlet Filter with Silencer
167691	1½" Polyester Cartridge Filter for 168412
167682	1¼" & 1½" Polyester Cartridge Filter for 168552S, 168554S & 168412L

VACUUM ACCESSORIES

169885	1½" Vacuum Relief Valve
168564	1½" Complete Vacuum Filter
167673	1½" Replacement Cartridge for 168564

ACCESSORIES - OTHER

169410	1½" Barrel Silencer (Threaded Single End)	1610880	Pressure Gauge 100 KPA/PS
169385	1½" Barrel Silencer (Threaded in/out)		
169770C	1½" Flux-Jet Threaded Flange Kit		

SERVICE KITS

FLUSK3	Flux-Jet 3 Phase - 5 Year Service Kit
--------	---------------------------------------



FLUX-JET 2.2

3PH SIDE CHANNEL BLOWER

Delivering the highest maximum pressure from the Flux-Jet 3-phase range. The Flux-Jet 2.2 is designed for 24/7 operation where reliability is critical.



DETAILS THAT MATTER

- » Low maintenance
- » Robust design



TECHNICAL DATA

FLUX-JET 2.2

Item Code	kW	Δ Delta Volt	Δ Delta Amp	Y Star Volt	Y Star Amp	Max. Air Flow m ³ /hr*	Max. Pressure mBar*	Max. Vacuum mBar*	Sound dB(A)	Height	Width	Depth	Weight Kg	Inlet & Outlet
048055	2.2	200-240	9	345-415	5.2	200	+265	-215	68	341	334	294	24	1½"

PRESSURE PERFORMANCE GRAPH

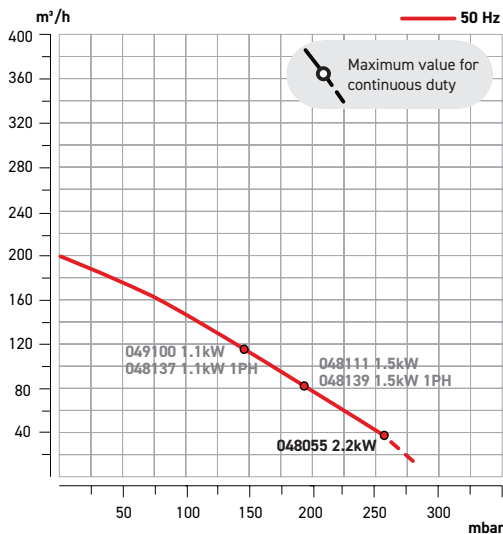

VACUUM PERFORMANCE GRAPH

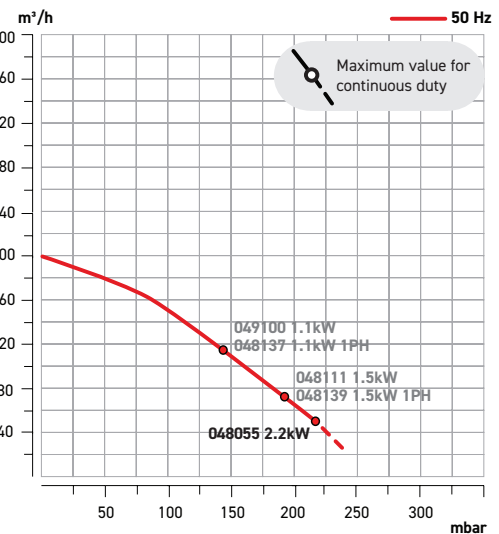

PRESSURE ACCESSORIES

169886	1½" Pressure Relief Valve
168553	1½" Mesh Inlet Filter
168412	1½" Complete Inlet Filter
167691	1½" Polyester Cartridge Filter for 168412
168554S	1½" Complete Inlet Filter with Silencer
167682	1¼" & 1½" Polyester Cartridge Filter for 168552S, 168554S & 168412L

VACUUM ACCESSORIES

169885	1½" Vacuum Relief Valve
168564	1½" Complete Vacuum Filter
167673	1½" Replacement Cartridge for 168564

ACCESSORIES - OTHER

169410	1½" Barrel Silencer (Threaded Single End)	1610880	Pressure Gauge 100 KPA/PS
169385	1½" Barrel Silencer (Threaded in/out)		
169770C	1½" Flux-Jet Threaded Flange Kit		

SERVICE KITS

FLUSK3	Flux-Jet 3 Phase - 5 Year Service Kit
--------	---------------------------------------

FLUX-JET 2V LHT

3PH SIDE CHANNEL BLOWER

The ESAM Flux-Jet 2V LHT (048161) is a two-stage blower that is designed to deliver higher pressure. This model includes heat resistant bearings.

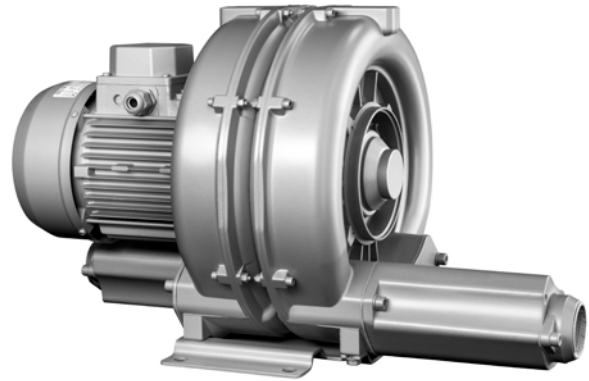

DETAILS THAT MATTER

- » Heat resistant bearings
- » Low maintenance
- » Robust design



TECHNICAL DATA											FLUX-JET 2V LHT			
Item Code	kW	Δ Delta Volt	Δ Delta Amp	Y Star Volt	Y Star Amp	Max. Air Flow m ³ /hr*	Max. Pressure mBar*	Max. Vacuum mBar*	Sound dB(A)	Height	Width	Depth	Weight Kg	Inlet & Outlet
048161	2.2	230	9	400	5.2	200	+265	-265	72	341	334	596.5	31	1½"

PRESSURE PERFORMANCE GRAPH

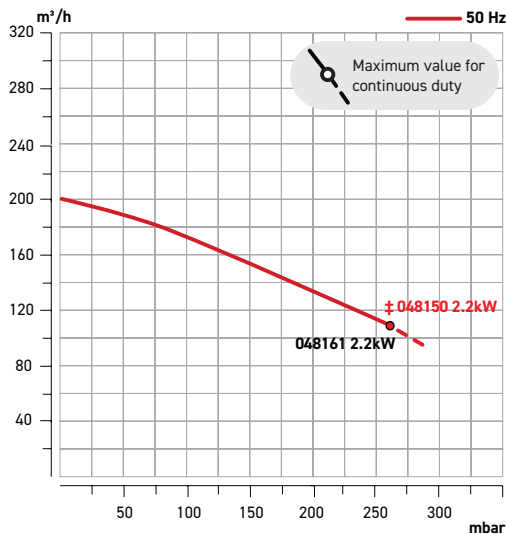

VACUUM PERFORMANCE GRAPH

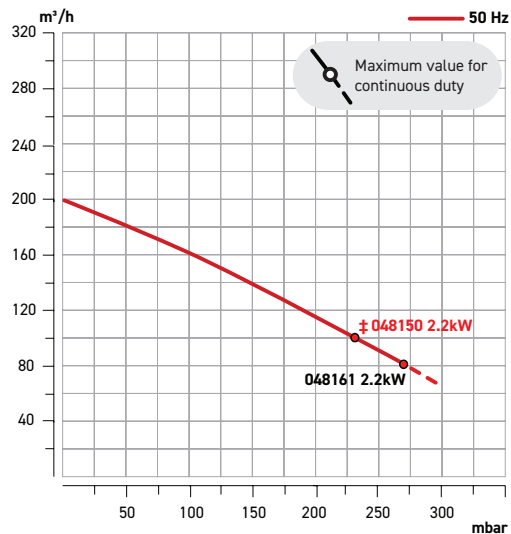

‡ POA/INIDENT

PRESSURE ACCESSORIES

169886	1½"	Pressure Relief Valve
168553	1½"	Mesh Inlet Filter
168412	1½"	Complete Inlet Filter
168554S	1½"	Complete Inlet Filter with Silencer
167691	1½"	Polyester Cartridge Filter for 168412
167682	1¼" & 1½"	Polyester Inlet Filter for 168552S, 168554S and 168412L

VACUUM ACCESSORIES

169885	1½"	Vacuum Relief Valve
168564	1½"	Complete Vacuum Filter
167673	1½"	Replacement Cartridge for 168564

ACCESSORIES - OTHER

169410	1½"	Barrel Silencer (Threaded Single End)	1610880	Pressure Gauge 100 KPA/PS
169385	1½"	Barrel Silencer (Threaded in/out)		
169770C	1½"	Flux-Jet Threaded Flange Kit		

SERVICE KITS

FLU2VLSK3	Flux-Jet 2V LHT 2.2kW Service Kit			
-----------	-----------------------------------	--	--	--



MEDIO-JET 2.2

3PH SIDE CHANNEL BLOWER

The Medio-Jet series of side channel blowers are often used mid to high air-flow applications. Common applications for the Medio-Jet 2.2 are vacuum transfer systems.



DETAILS THAT MATTER

- » Low maintenance
- » Robust design



TECHNICAL DATA												MEDIO-JET 2.2			
Item Code	kW	Δ Delta Volt	Δ Delta Amp	Y Star Volt	Y Star Amp	Max. Air Flow m ³ /hr*	Max. Pressure mBar*	Max. Vacuum mBar*	Sound dB(A)	Height	Width	Depth	Weight Kg	Inlet & Outlet	
061502	2.2	230	9	400	5.2	330	+185	-195	76	415	395	332	30	2"	

PRESSURE PERFORMANCE GRAPH

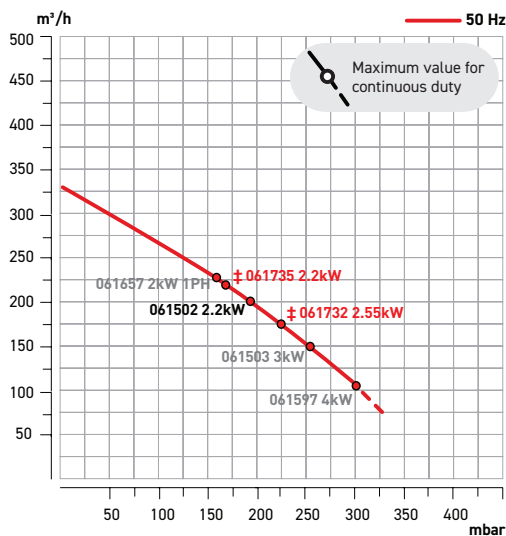

VACUUM PERFORMANCE GRAPH

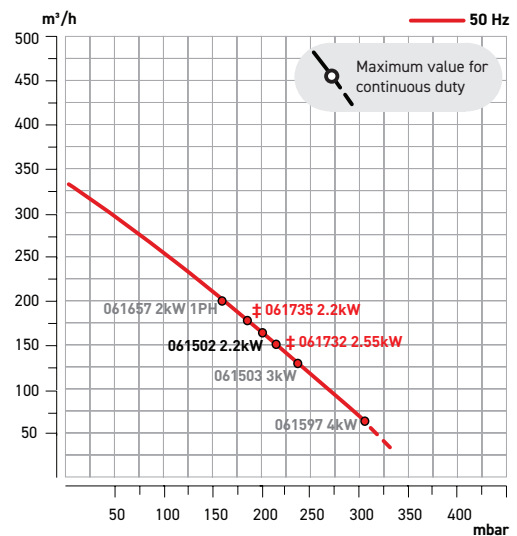

‡ POA/INDEXT

PRESSURE ACCESSORIES

169858	2" Pressure Relief Valve
168555	2" Mesh Inlet Filter
168491	2" Complete Inlet Filter
167692	2" Polyester Cartridge Filter for 168491
168556S	2" Complete Inlet Filter with Silencer
167670S	2" & 2½" Polyester Inlet Filter S Type

VACUUM ACCESSORIES

169846	2" Vacuum Relief Valve
168561	2" Complete Vacuum Filter
167672	2" & 2½" Replacement Cartridge for 168561 & 168543

ACCESSORIES - OTHER

169413	2" Barrel Silencer (Threaded in/out)	169751C	2" Medio-Jet, 1AC & 2V Threaded Flange Kit
169372	2" Barrel Silencer (Threaded single end)	1610880	Pressure Gauge 100 KPA/PS

SERVICE KITS

MEDSK3	Medio-Jet 2.2kW - 3kW 3 Phase - 5 Year Service Kit
--------	--

MEDIO-JET 3

3PH SIDE CHANNEL BLOWER

Delivering the a maximum vacuum of -230mBar the Medio-Jet 3 is commonly used in vacuum transfer systems. ESAM side channel blowers are designed for 24/7 operation.



DETAILS THAT MATTER

- » Low maintenance
- » Robust design



TECHNICAL DATA											MEDIO-JET 3			
Item Code	kW	Δ Delta Volt	Δ Delta Amp	Y Star Volt	Y Star Amp	Max. Air Flow m³/hr*	Max. Pressure mBar*	Max. Vacuum mBar*	Sound dB(A)	Height	Width	Depth	Weight Kg	Inlet & Outlet
061503	3	230	11.8	400	6.8	330	+245	-230	76	415	395	357	32	2"

PRESSURE PERFORMANCE GRAPH

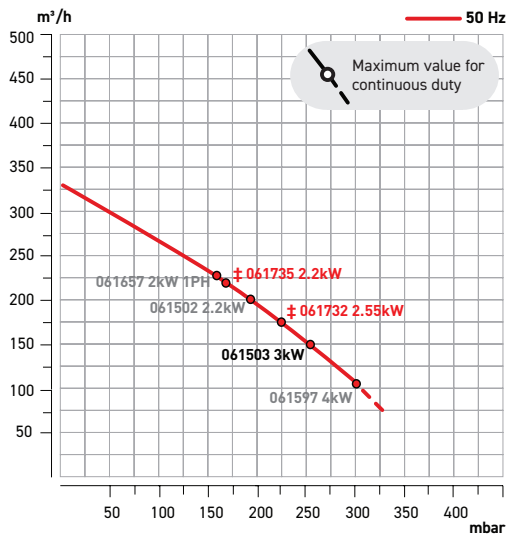

VACUUM PERFORMANCE GRAPH

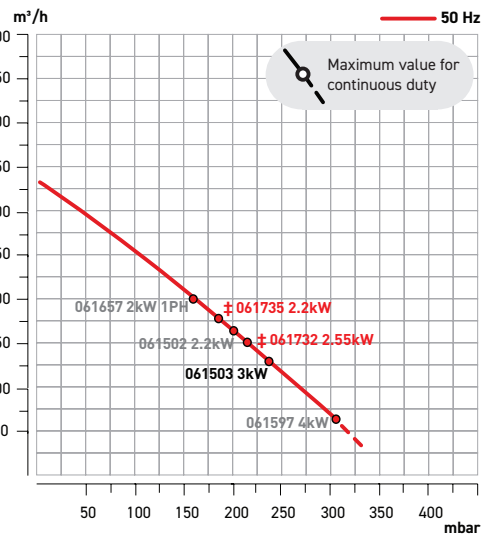

‡ POA/INDEPEND

PRESSURE ACCESSORIES

169858	2" Pressure Relief Valve
168555	2" Mesh Inlet Filter
168491	2" Complete Inlet Filter
167692	2" Polyester Cartridge Filter for 168491
168556S	2" Complete Inlet Filter with Silencer
167670S	2" & 2½" Polyester Inlet Filter S Type

VACUUM ACCESSORIES

169846	2" Vacuum Relief Valve
168561	2" Complete Vacuum Filter
167672	2" & 2½" Replacement Cartridge for 168561 & 168543

ACCESSORIES - OTHER

169413	2" Barrel Silencer (Threaded in/out)	169751C	2" Medio-Jet, 1AC & 2V Threaded Flange Kit
169372	2" Barrel Silencer (Threaded single end)	1610880	Pressure Gauge 100 KPA/PS

SERVICE KITS

MEDSK3	Medio-Jet 2.2kW - 3kW 3 Phase - 5 Year Service Kit
--------	--

MEDIO-JET 2V LHT

3PH SIDE CHANNEL BLOWER

The ESAM Medio-Jet 2V LHT delivers a higher pressure and includes heat resistant bearings. This system is often used in aquaculture, agriculture and aquatic markets.

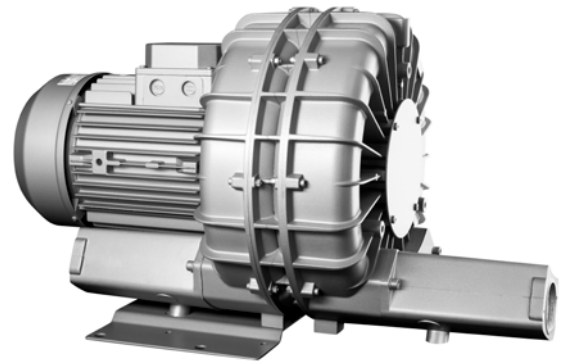

DETAILS THAT MATTER

- » Heat resistant bearings
- » Low maintenance
- » Robust design



TECHNICAL DATA

MEDIO-JET 2V LHT

Item Code	kW	Δ Delta Volt	Δ Delta Amp	Y Star Volt	Y Star Amp	Max. Air Flow m ³ /hr*	Max. Pressure mBar*	Max. Vacuum mBar*	Sound dB(A)	Height	Width	Depth	Weight Kg	Inlet & Outlet
091624	5.5	200-240	22.5	345-415	13	330	+440	-390	77	415	395	709	60	2"

PRESSURE PERFORMANCE GRAPH

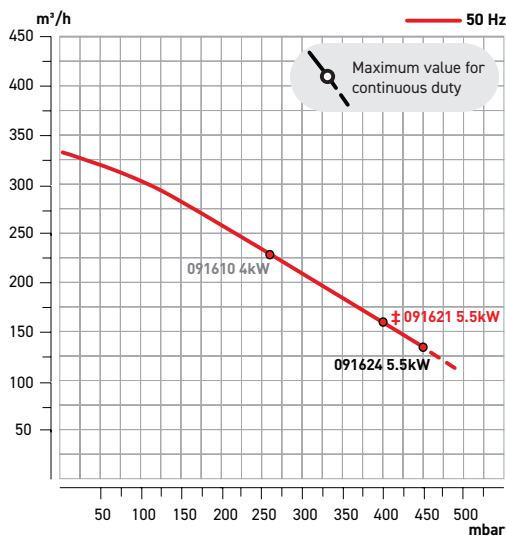

VACUUM PERFORMANCE GRAPH

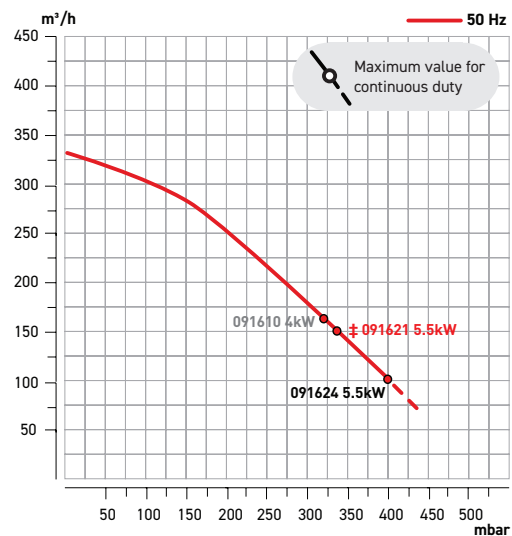

‡ POA/INIDENT

PRESSURE ACCESSORIES

169858	2" Pressure Relief Valve
168555	2" Mesh Inlet Filter
168491	2" Complete Inlet Filter
168556S	2" Complete Inlet Filter with Silencer
167692	2" Polyester Cartridge Filter for 168491
167670S	2" & 2½" Polyester Inlet Filter S Type

VACUUM ACCESSORIES

169846	2" Vacuum Relief Valve
168561	2" Complete Vacuum Filter
167672	2" & 2½" Replacement Cartridge for 168561 & 168543

ACCESSORIES - OTHER

169413	2" Barrel Silencer (Threaded in/out)	169751C	Medio-Jet, 1AC & 2V Threaded Flange Kit
169372	2" Barrel Silencer (Threaded single end)	1610880	Pressure Gauge 100 KPA/PS
169412	2" Barrel Silencer (Threaded in/out)		

SERVICE KITS

MED2VLSK3	Medio-Jet 2V LHT Service Kit
-----------	------------------------------

UNI-JET 160

3PH SIDE CHANNEL BLOWER

Providing a maximum of +440 mBar pressure is ideal for high pressure applications such as certain water treatment applications.

DETAILS THAT MATTER

- » Low maintenance
- » Robust design



5 YEARS WARRANTY

LOW NOISE & VIBRATION

IP55

MADE IN ITALY

24 CONTINUOUS DUTY RATED 7

THERMAL SENSOR

INVERTER COMPATIBLE

TECHNICAL DATA											UNI-JET 160			
Item Code	kW	Δ Delta Volt	Δ Delta Amp	Y Star Volt	Y Star Amp	Max. Air Flow m ³ /hr*	Max. Pressure mBar*	Max. Vacuum mBar*	Sound dB(A)	Height	Width	Depth	Weight Kg	Inlet & Outlet
056500	4	200-240	16.7	345-415	9.7	160	+440	-345	78	543.5	480	502.5	62	1½"

PRESSURE PERFORMANCE GRAPH

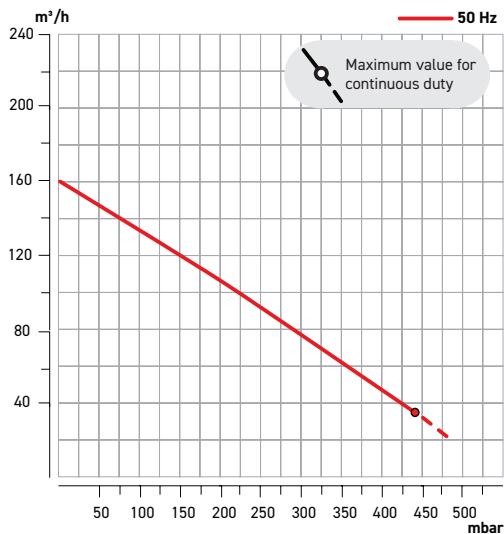

VACUUM PERFORMANCE GRAPH

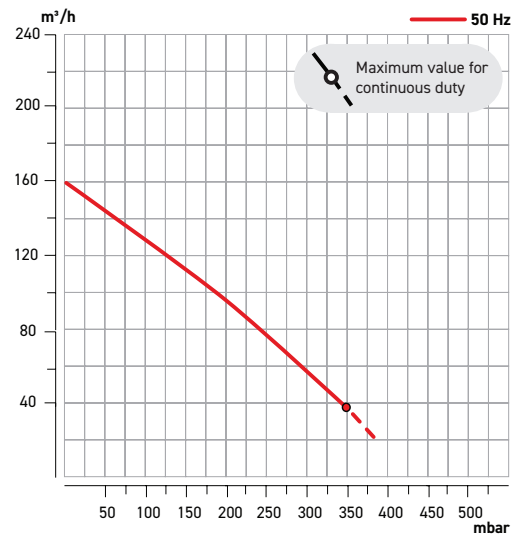

PRESSURE ACCESSORIES

169888	1½" Pressure Relief Valve - Uni-Jet 160
169856	1½" Pressure Relief Valve - Uni-Jet 160
168553	1½" Mesh Inlet Filter
168412	1½" Complete Inlet Filter
168554S	1½" Complete Inlet Filter with Silencer
167691	1½" Polyester Cartridge Filter for 168412
167682	1¼" & 1½" Polyester Cartridge Filter for 168552S & 168554S

VACUUM ACCESSORIES

169887	Vacuum Relief Valve
169849	1½" Vacuum Relief Valve - Uni-Jet 160

ACCESSORIES - OTHER

169410	1½" Barrel Silencer (Threaded Single End)	169751C	2" Flux-Jet Threaded Flange Kit
169385	1½" Barrel Silencer (Threaded in/out)	1610880	Pressure Gauge 100 KPA/PS
169770C	1½" Flux-Jet Threaded Flange Kit		

SERVICE KITS

UNI160SK3	Uni-Jet 160 4kW 3 Phase Service Kit
-----------	-------------------------------------

MEDIO-JET 350

3PH SIDE CHANNEL BLOWER

Delivering the a maximum vacuum of -300mBar and maximum pressure of +290mBar the Medio-Jet 350 is designed for 24/7 operation.



DETAILS THAT MATTER

- » Low maintenance
- » Robust design



TECHNICAL DATA												MEDIO-JET 350			
Item Code	kW	Δ Delta Volt	Δ Delta Amp	Y Star Volt	Y Star Amp	Max. Air Flow m ³ /hr*	Max. Pressure mBar*	Max. Vacuum mBar*	Sound dB(A)	Height	Width	Depth	Weight Kg	Inlet & Outlet	
061752	4	200-240	16.7	345-415	9.7	370	+290	-300	76	415	395	410	44	2"	

PRESSURE PERFORMANCE GRAPH

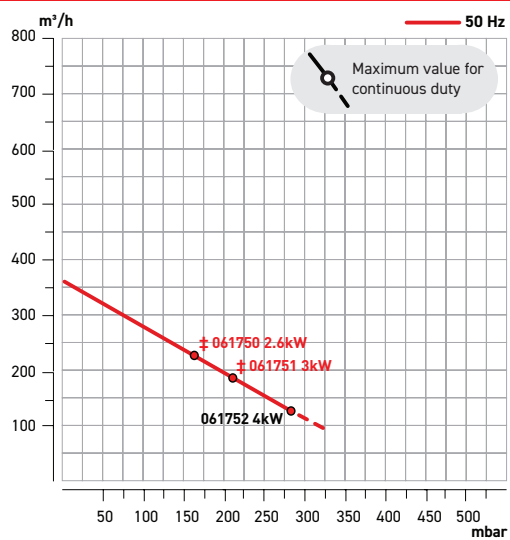

VACUUM PERFORMANCE GRAPH

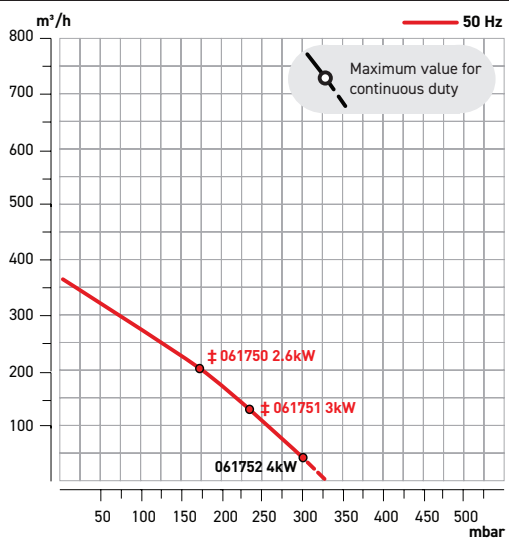

‡ POA/INDEnt

PRESSURE ACCESSORIES

169858	2" Pressure Relief Valve
168555	2" Mesh Inlet Filter
168491	2" Complete Inlet Filter
167670S	2" & 2½" Polyester Inlet Filter S Type
167692	2" Polyester Cartridge Filter for 168491
168556S	2" Complete Inlet Filter with Silencer

VACUUM ACCESSORIES

169846	2" Vacuum Relief Valve
168561	2" Complete Vacuum Filter
167672	2" & 2½" Replacement Cartridge for 168561 & 168543

ACCESSORIES - OTHER

169413	2" Barrel Silencer (Threaded in/out)	169751C	2" Medio-Jet, 1AC & 2V Threaded Flange Kit
169372	2" Barrel Silencer (Threaded single end)	1610880	Pressure Gauge 100 KPA/PS

SERVICE KITS

MEDLSK3	Medio-Jet LHT 4kW & Medio-Jet 350 4kW Service Kit
---------	---



MEDIO-JET 2V

3PH SIDE CHANNEL BLOWER

The 2V series of side channel blowers provide greater pressure through two-stage impeller design. The Medio-Jet 2V is most often used in commercial aquatic applications due to its robust and reliable operation.

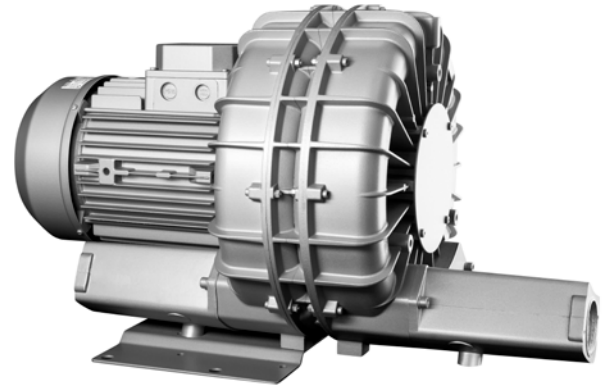

DETAILS THAT MATTER

- » Low maintenance
- » Two-stage for higher pressure

5 YEARS WARRANTY

LOW NOISE & VIBRATION

IP55

MADE IN ITALY

24 CONTINUOUS DUTY RATED 7

THERMAL SENSOR

INVERTER COMPATIBLE

TECHNICAL DATA											MEDIO-JET 2V			
Item Code	kW	Δ Delta Volt	Δ Delta Amp	Y Star Volt	Y Star Amp	Max. Air Flow m³/hr*	Max. Pressure mBar*	Max. Vacuum mBar*	Sound dB(A)	Height	Width	Depth	Weight Kg	Inlet & Outlet
091610	4	200-240	16.7	345-415	9.7	330	+260	-315	77	415	395	732	57	2"

PRESSURE PERFORMANCE GRAPH

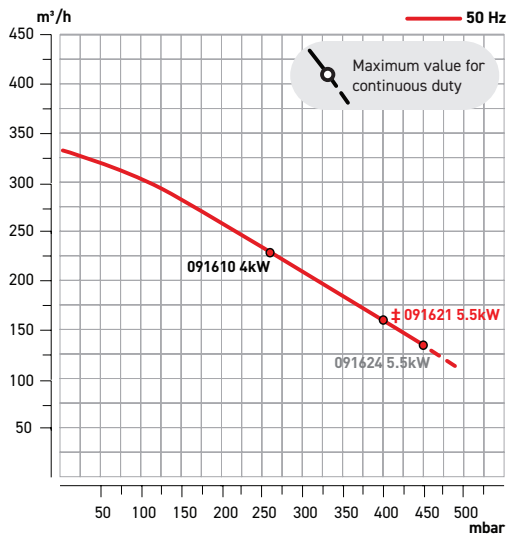

VACUUM PERFORMANCE GRAPH

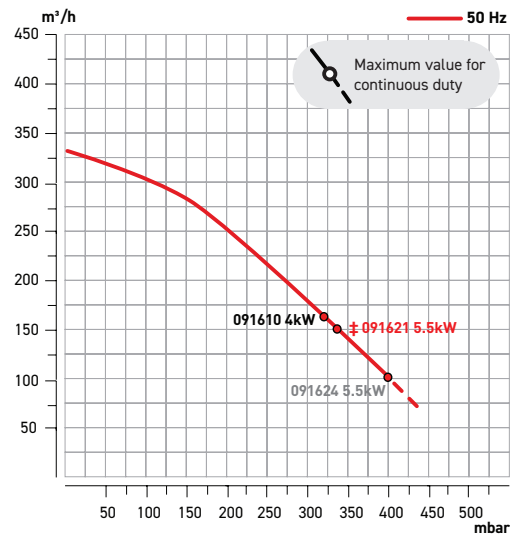

‡ POA/INDEPEND

PRESSURE ACCESSORIES

169858	2" Pressure Relief Valve
168555	2" Mesh Inlet Filter
168491	2" Complete Inlet Filter
167670S	2" & 2½" Polyester Inlet Filter S Type
167692	2" Polyester Cartridge Filter for 168491
168556S	2" Complete Inlet Filter with Silencer

VACUUM ACCESSORIES

169846	2" Vacuum Relief Valve
168561	2" Complete Vacuum Filter
167672	2" & 2½" Replacement Cartridge for 168561 & 168543

ACCESSORIES - OTHER

169413	2" Barrel Silencer (Threaded in/out)	169751C	2" Threaded Flange Kit
169372	2" Barrel Silencer (Threaded single end)	1610880	Pressure Gauge 100 KPA/PS

SERVICE KITS

MED2VSK3	Medio-Jet 2V 4kW & 5.5kW Service Kit
----------	--------------------------------------

MEDIO-JET LHT

3PH SIDE CHANNEL BLOWER

Delivering a maximum pressure of +295 mBar or a maximum of -295 mBar vacuum the Medio-Jet LHT is used across numerous industries. Incorporating heat resistant bearings and a robust aluminium design this side channel blower delivers years of reliable service.



DETAILS THAT MATTER

- » Low maintenance
- » Heat resistant bearings



TECHNICAL DATA

MEDIO-JET LHT

Item Code	kW	Δ Delta Volt	Δ Delta Amp	Y Star Volt	Y Star Amp	Max. Air Flow m ³ /hr*	Max. Pressure mBar*	Max. Vacuum mBar*	Sound dB(A)	Height	Width	Depth	Weight Kg	Inlet & Outlet
061597	4	200-240	16.7	345-415	9.7	330	+295	-295	76	415	395	410	44	2"

PRESSURE PERFORMANCE GRAPH

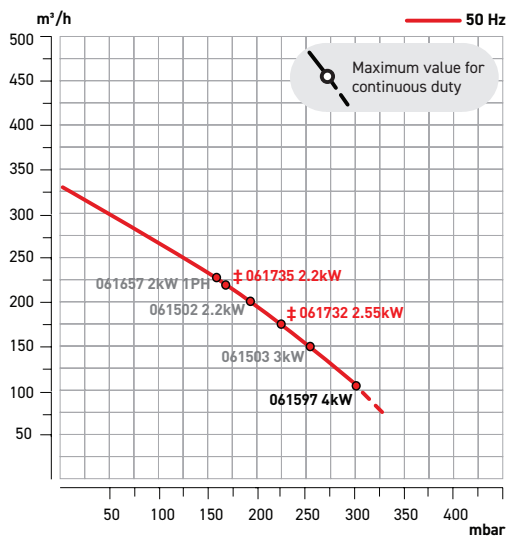

VACUUM PERFORMANCE GRAPH

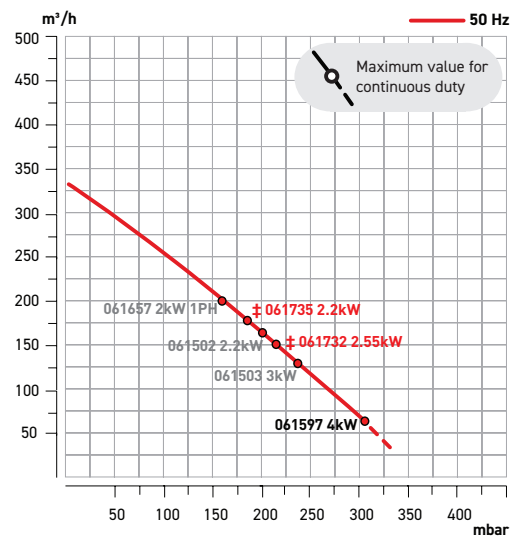

‡ POA/INIDENT

PRESSURE ACCESSORIES

169858	2" Pressure Relief Valve
168555	2" Mesh Inlet Filter
168491	2" Complete Inlet Filter
167670S	2" & 2½" Polyester Inlet Filter S Type
167692	2" Polyester Cartridge Filter for 168491
168556S	2" Complete Inlet Filter with Silencer

VACUUM ACCESSORIES

169846	2" Vacuum Relief Valve
168561	2" Complete Vacuum Filter
167672	2" & 2½" Replacement Cartridge for 168561 & 168543

ACCESSORIES - OTHER

169413	2" Barrel Silencer (Threaded in/out)	169751C	2" Medio-Jet, 1AC & 2V Threaded Flange Kit
169372	2" Barrel Silencer (Threaded single end)	1610880	Pressure Gauge 100 KPA/PS

SERVICE KITS

MEDLSK3	Medio-Jet LHT 4kW & Medio-Jet 350 4kW Service Kit
---------	---

MEDIO-JET 1AC 4

3PH SIDE CHANNEL BLOWER

The ESAM 1AC side channel blowers are a two-stage side channel blower that have been specifically engineered to provide high volume of air flow. This series is available in a 4kW and 5.5kW version.

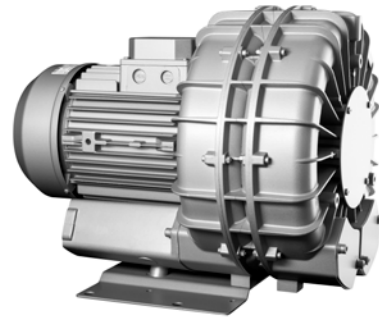

DETAILS THAT MATTER

» Ideal for Aquaculture and irrigation applications



TECHNICAL DATA											MEDIO-JET 1AC 4				
Item Code	kW	Δ Delta Volt	Δ Delta Amp	Y Star Volt	Y Star Amp	Max. Air Flow m ³ /hr*	Max. Pressure mBar*	Max. Vacuum mBar*	Sound dB(A)	Height	Width	Depth	Weight Kg	Inlet & Outlet	
091950	4	200-240	16.7	345-415	9.7	500	+105	-135	77	415	395	530	56	2"	

PRESSURE PERFORMANCE GRAPH

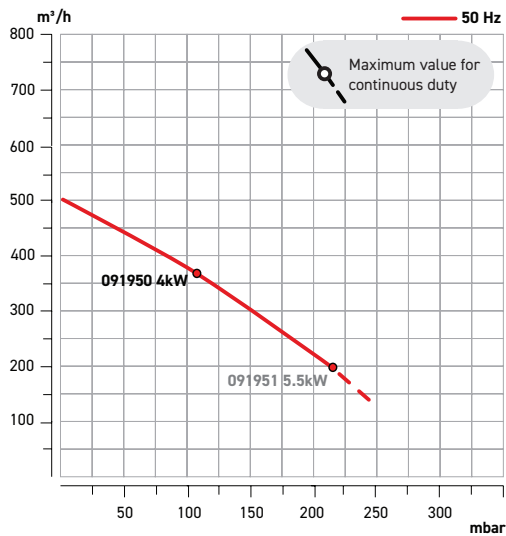

VACUUM PERFORMANCE GRAPH

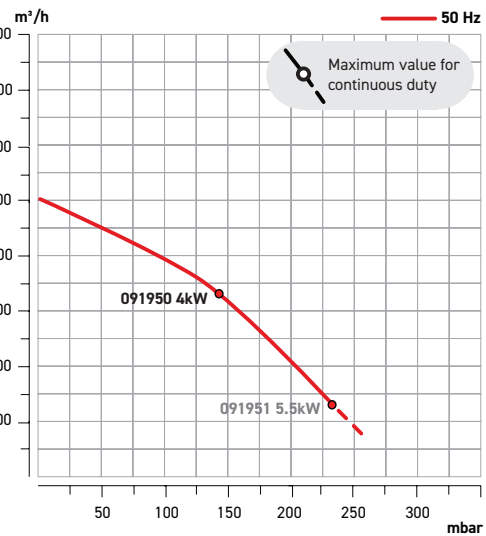

PRESSURE ACCESSORIES

169857	3" Pressure Relief Valve
168491	2" Complete Inlet Filter
168556S	2" Complete Inlet Filter with Silencer
167670S	2" & 2½" Polyester Inlet Filter S Type
167692	2" Polyester Cartridge Filter for 168491

VACUUM ACCESSORIES

169844	3" Vacuum Relief Valve
168561	2" Complete Vacuum Filter
167672	2" & 2½" Replacement Cartridge for 168561 & 168543

ACCESSORIES - OTHER

169751C	2" Medio-Jet, 1AC & 2V Threaded Flange Kit	169372	One Ended Supplementary Silencer
169412	One Ended Supplementary Silencer	1610880	Pressure Gauge 100 KPA/PS

SERVICE KITS

MED1ACSK3	Medio-Jet 1AC 4 & 5.5kW 3PH 5 Year Service Kit
-----------	--

MEDIO-JET 1AC 5.5

3PH SIDE CHANNEL BLOWER

The ESAM Medio-Jet 1AC 5.5 is the larger of the two-stage side channel blowers that are engineered to provide a high volume of air flow.

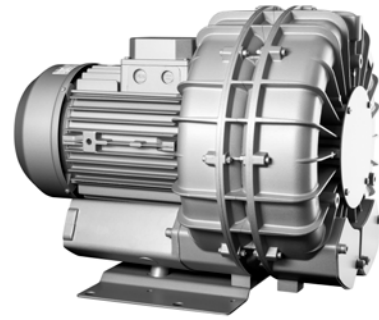

DETAILS THAT MATTER

» Ideal for Aquaculture and irrigation applications



TECHNICAL DATA													MEDIO-JET 1AC 5.5		
Item Code	kW	Δ Delta Volt	Δ Delta Amp	Y Star Volt	Y Star Amp	Max. Air Flow m ³ /hr*	Max. Pressure mBar*	Max. Vacuum mBar*	Sound dB(A)	Height	Width	Depth	Weight Kg	Inlet & Outlet	
091951	5.5	200-240	22.5	345-415	13	500	+215	-225	77	415	395	530	56	2"	

PRESSURE PERFORMANCE GRAPH

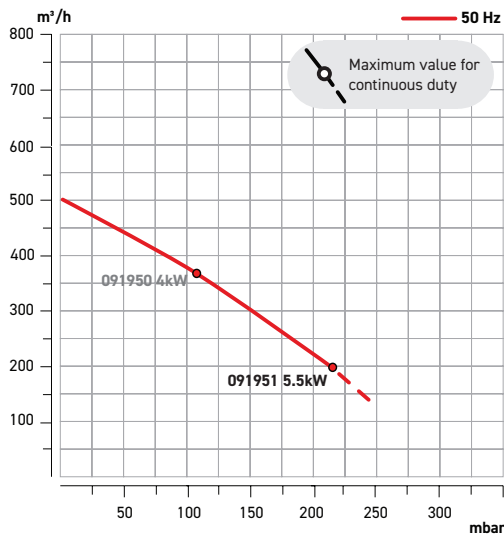

VACUUM PERFORMANCE GRAPH

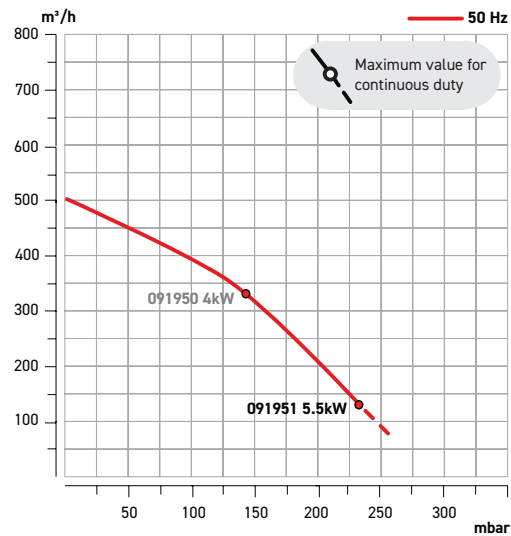

PRESSURE ACCESSORIES

169857	3" Pressure Relief Valve
168491	2" Complete Inlet Filter
168556S	2" Complete Inlet Filter with Silencer
167670S	2" & 2½" Polyester Inlet Filter S Type
167692	2" Polyester Cartridge Filter for 168491

VACUUM ACCESSORIES

169844	3" Vacuum Relief Valve
168561	2" Complete Vacuum Filter
167672	2" & 2½" Replacement Cartridge for 168561 & 168543

ACCESSORIES - OTHER

169751C	2" Medio-Jet, 1AC & 2V Threaded Flange Kit	169372	One Ended Supplementary Silencer
169412	One Ended Supplementary Silencer	1610880	Pressure Gauge 100 KPA/PS

SERVICE KITS

MED1ACSK3	Medio-Jet 1AC 4 & 5.5kW 3PH 5 Year Service Kit
-----------	--

UNI-JET 501 5.5

3PH SIDE CHANNEL BLOWER

The UNI-JET 500 to UNI-JET 2200 side channel blowers are ESAMs' single stage high airflow systems. The 501 series are available in a 5.5 or 7.5kW system with the 4kW available as a special order only model.



DETAILS THAT MATTER

- » Dynamically balanced
- » Low maintenance design
- » High-quality materials and design

5 YEARS WARRANTY

LOW NOISE & VIBRATION

IP55

MADE IN ITALY

24/7 CONTINUOUS DUTY RATED

THERMAL SENSOR

INVERTER COMPATIBLE

TECHNICAL DATA UNI-JET 501 5.5

Item Code	kW	Δ Delta Volt	Δ Delta Amp	Y Star Volt	Y Star Amp	Max. Air Flow m³/hr*	Max. Pressure mBar*	Max. Vacuum mBar*	Sound dB(A)	Height	Width	Depth	Weight Kg	Inlet & Outlet
079510	5.5	200-240	22.5	345-415	13	500	+245	-255	78	522	456	433	88	2½"

PRESSURE PERFORMANCE GRAPH

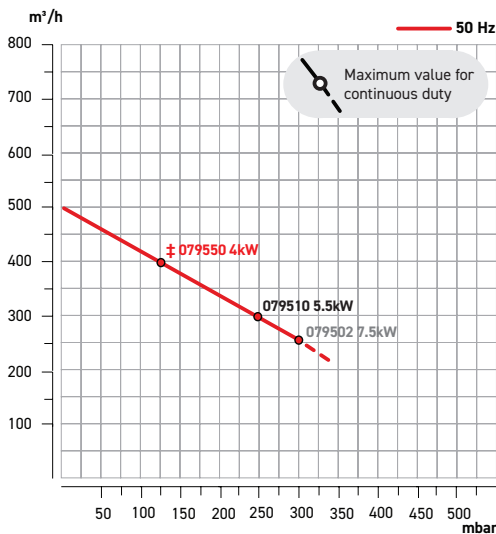

VACUUM PERFORMANCE GRAPH

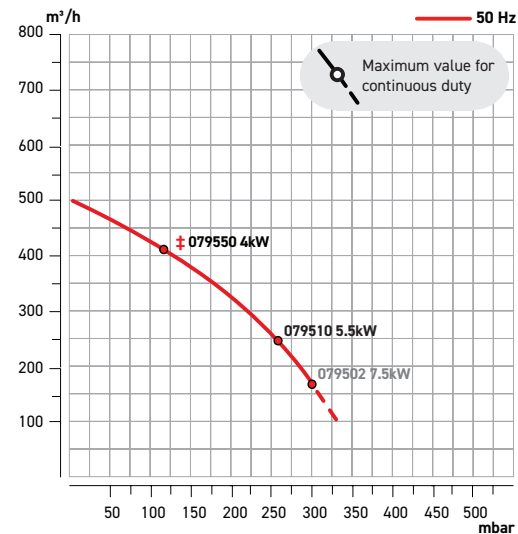

‡ POA/INIDENT

PRESSURE ACCESSORIES

169857	3" Pressure Relief Valve
168534	2½" Complete Inlet Filter
167670S	2" & 2½" Polyester Inlet Filter S Type
167670	2½" Polyester Cartridge Filter for 168534
168536S	2½" Complete Inlet Filter with Silencer
168534L	2½" Complete Inlet Filter

VACUUM ACCESSORIES

169844	3" Vacuum Relief Valve
168543	2½" Complete Vacuum Filter
167672	2" & 2½" Replacement Cartridge for 168561 & 168543

ACCESSORIES - OTHER

169376	2½" Barrel Silencer (Threaded in/out)	1610880	Pressure Gauge 100 KPA/PS
--------	---------------------------------------	---------	---------------------------

SERVICE KITS

UNI501SK3	Uni-Jet 501 3Phase Major Service Kit
-----------	--------------------------------------

UNI-JET 501 7.5

3PH SIDE CHANNEL BLOWER

The 501 series are available in a 5.5 or 7.5kW system with the 4kW available as a special order only model. The 7.5kW version provides an impressive 500m³/hr maximum air flow.



DETAILS THAT MATTER

- » Dynamically balanced
- » Low maintenance design
- » High-quality materials and design



TECHNICAL DATA

UNI-JET 501 7.5

Item Code	kW	Δ Delta Volt	Δ Delta Amp	Y Star Volt	Y Star Amp	Max. Air Flow m ³ /hr*	Max. Pressure mBar*	Max. Vacuum mBar*	Sound dB(A)	Height	Width	Depth	Weight Kg	Inlet & Outlet
079502	7.5	200-240	17.8	690	10.28	500	+285	-295	78	522	456	491	88	2½"

PRESSURE PERFORMANCE GRAPH

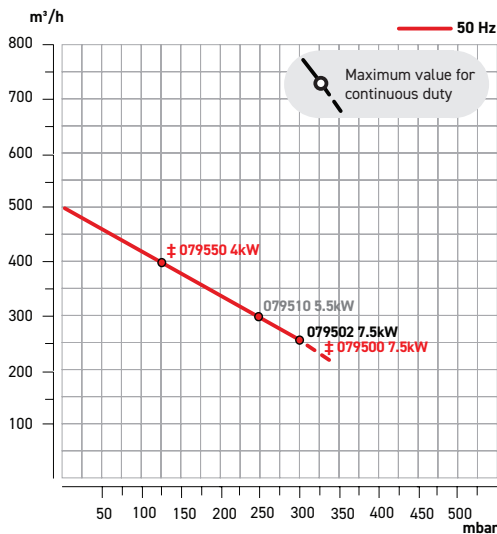

VACUUM PERFORMANCE GRAPH

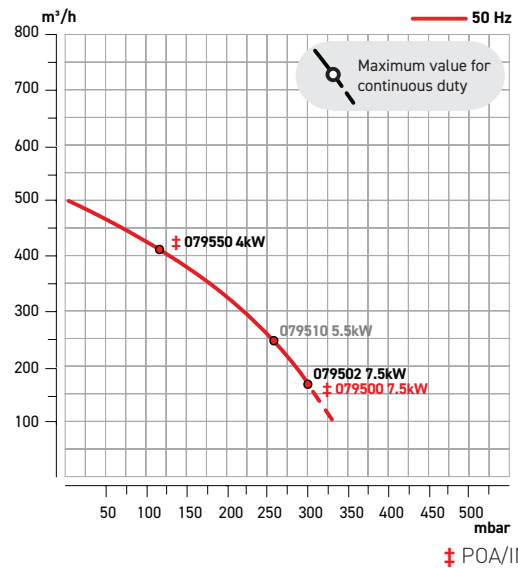

PRESSURE ACCESSORIES

169857	3" Pressure Relief Valve
168534	2½" Complete Inlet Filter
167670S	2" & 2½" Polyester Inlet Filter S Type
167670	2½" Polyester Cartridge Filter for 168534
168536S	2½" Complete Inlet Filter with Silencer
168534L	2½" Complete Inlet Filter

VACUUM ACCESSORIES

169844	3" Vacuum Relief Valve
168543	2½" Complete Vacuum Filter
167672	2" & 2½" Replacement Cartridge for 168561 & 168543

ACCESSORIES - OTHER

169376	2½" Barrel Silencer (Threaded in/out)	1610880	Pressure Gauge 100 KPA/PS
--------	---------------------------------------	---------	---------------------------

SERVICE KITS

UNI501SK3	Uni-Jet 501 3Phase Major Service Kit
-----------	--------------------------------------

UNI-JET 500 7.5

3PH SIDE CHANNEL BLOWER

The UNI-JET 500 series of side channel blowers begins at 7.5kW and goes up to a 12.5kW system. The 11kW version is only available by special order.



DETAILS THAT MATTER

- » Rigorously tested to extremes
- » Low maintenance design
- » High-quality materials and design

5 YEARS WARRANTY

LOW NOISE & VIBRATION

IP55

MADE IN ITALY

24/7 CONTINUOUS DUTY RATED

THERMAL SENSOR

INVERTER COMPATIBLE

TECHNICAL DATA											UNI-JET 500 7.5			
Item Code	kW	Δ Delta Volt	Δ Delta Amp	Y Star Volt	Y Star Amp	Max. Air Flow m³/hr*	Max. Pressure mBar*	Max. Vacuum mBar*	Sound dB(A)	Height	Width	Depth	Weight Kg	Inlet & Outlet
080006	7.5	345-415	17.8	690	10.28	600	+285	-295	78	583.5	530	566	96	2½"

PRESSURE PERFORMANCE GRAPH

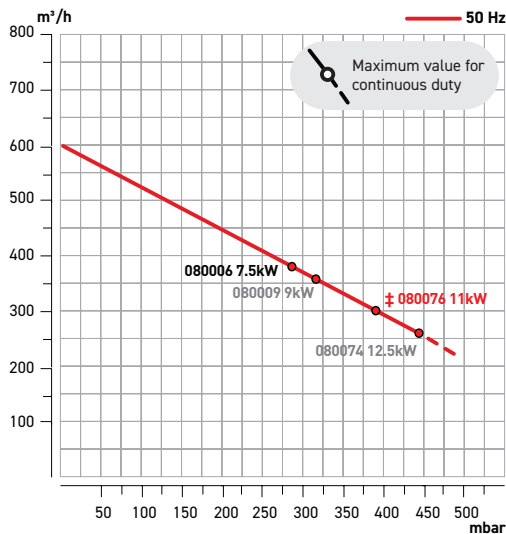

VACUUM PERFORMANCE GRAPH

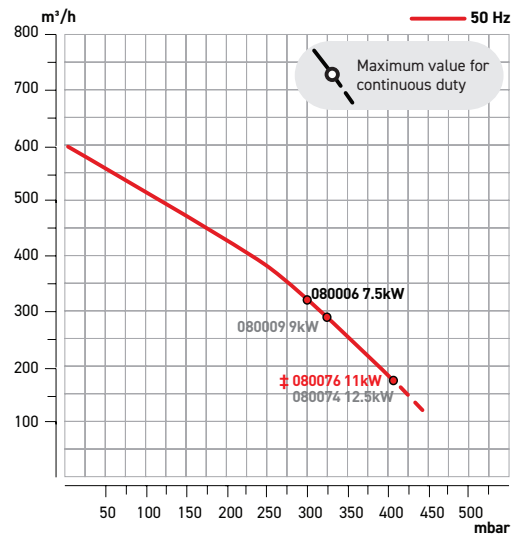

‡ POA/INDEPEND

PRESSURE ACCESSORIES

169857	3" Pressure Relief Valve
168534	2½" Complete Inlet Filter
167670S	2" & 2½" Polyester Inlet Filter S Type
167670	2½" Polyester Cartridge Filter for 168534
168536S	2½" Complete Inlet Filter with Silencer

VACUUM ACCESSORIES

169844	3" Vacuum Relief Valve
168543	2½" Complete Vacuum Filter
167672	2" & 2½" Replacement Cartridge for 168561 & 168543

ACCESSORIES - OTHER

169415	Silencer 2.5i" Uni-Jet 500	169376	2½" Barrel Silencer (Threaded in/out)
1610880	Pressure Gauge 100 KPA/PS		

SERVICE KITS

UNI500SK3	Uni-Jet 500 3Phase Major Service Kit
-----------	--------------------------------------

UNI-JET 500 9

3PH SIDE CHANNEL BLOWER

The UNI-JET 500 9 side channel blowers delivers a maximum air flow of 600m³/hr. ESAM side channel blowers are designed to perform at a high level of precision and durability, operating 24/7 at maximum output.



DETAILS THAT MATTER

- » Rigorously tested to extremes
- » Low maintenance design
- » High-quality materials and design



TECHNICAL DATA

UNI-JET 500 9

Item Code	kW	Δ Delta Volt	Δ Delta Amp	Y Star Volt	Y Star Amp	Max. Air Flow m ³ /hr*	Max. Pressure mBar*	Max. Vacuum mBar*	Sound dB(A)	Height	Width	Depth	Weight Kg	Inlet & Outlet
080009	9	345-415	22.3	690	12.88	600	+320	-315	78	583.5	530	566	102	2½"

PRESSURE PERFORMANCE GRAPH

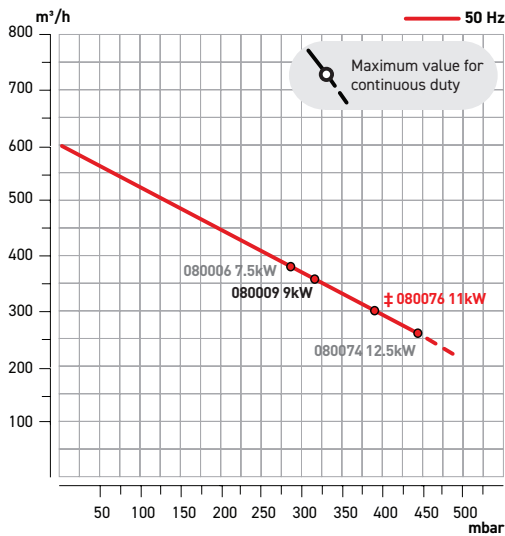

VACUUM PERFORMANCE GRAPH

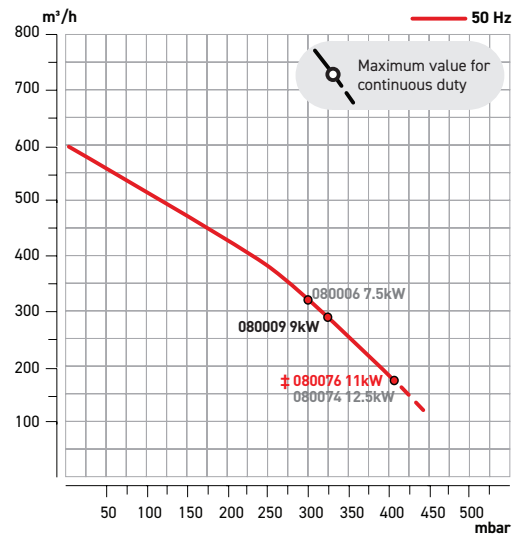

‡ POA/INDEXT

PRESSURE ACCESSORIES

169857	3" Pressure Relief Valve
168534	2½" Complete Inlet Filter
167670S	2" & 2½" Polyester Inlet Filter S Type
167670	2½" Polyester Cartridge Filter for 168534
168536S	2½" Complete Inlet Filter with Silencer

VACUUM ACCESSORIES

169844	3" Vacuum Relief Valve
168543	2½" Complete Vacuum Filter
167672	2" & 2½" Replacement Cartridge for 168561 & 168543

ACCESSORIES - OTHER

169415	Silencer 2.5" Uni-Jet 500	169376	2½" Barrel Silencer (Threaded in/out)
1610880	Pressure Gauge 100 KPA/PS		

SERVICE KITS

UNI500SK3	Uni-Jet 500 3Phase Major Service Kit
-----------	--------------------------------------

UNI-JET 500 12.5

3PH SIDE CHANNEL BLOWER

The UNI-JET 500 12.5 side channel blowers is the largest kilowatt system of the 500 series and is designed for durability and to operate 24 hours a day at maximum output.



DETAILS THAT MATTER

- » Rigorously tested to extremes
- » Low maintenance design
- » High-quality materials and design

5 YEARS WARRANTY

LOW NOISE & VIBRATION

IP55

MADE IN ITALY

24 CONTINUOUS DUTY RATED 7

THERMAL SENSOR

INVERTER COMPATIBLE

TECHNICAL DATA											UNI-JET 500 12.5			
Item Code	kW	Δ Delta Volt	Δ Delta Amp	Y Star Volt	Y Star Amp	Max. Air Flow m³/hr*	Max. Pressure mBar*	Max. Vacuum mBar*	Sound dB(A)	Height	Width	Depth	Weight Kg	Inlet & Outlet
080074	12.5	345-415	26.8	690	15.47	600	+465	-390	78	583.5	530	604	112	2½"

PRESSURE PERFORMANCE GRAPH

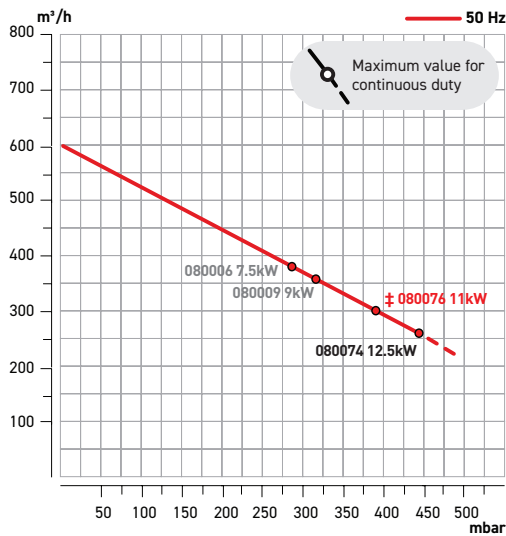

VACUUM PERFORMANCE GRAPH

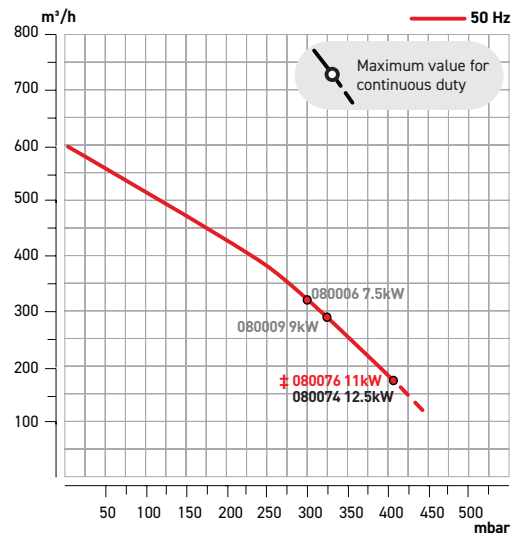

‡ POA/INIDENT

PRESSURE ACCESSORIES

169857	3" Pressure Relief Valve
168534	2½" Complete Inlet Filter
167670S	2" & 2½" Polyester Inlet Filter S Type
167670	2½" Polyester Cartridge Filter for 168534
168536S	2½" Complete Inlet Filter with Silencer

VACUUM ACCESSORIES

169844	3" Vacuum Relief Valve
168543	2½" Complete Vacuum Filter
167672	2" & 2½" Replacement Cartridge for 168561 & 168543

ACCESSORIES - OTHER

169415	Silencer 2.5" Uni-Jet 500	169376	2½" Barrel Silencer (Threaded in/out)
1610880	Pressure Gauge 100 KPA/PS		

SERVICE KITS

UNI500SK3	Uni-Jet 500 3Phase Major Service Kit
-----------	--------------------------------------

UNI-JET 1000 11

3PH SIDE CHANNEL BLOWER

The UNI-JET 1000 series has three models in the range, starting at 11kW and moving up to 20kW. These versions are designed to meet the needs of 1,200m³/hr at varying pressure or vacuum requirements.



DETAILS THAT MATTER

- » Proven design for longevity
- » Designed to operate 24/7
- » High-quality build



TECHNICAL DATA

UNI-JET 1000 11

Item Code	kW	Δ Delta Volt	Δ Delta Amp	Y Star Volt	Y Star Amp	Max. Air Flow m ³ /hr*	Max. Pressure mBar*	Max. Vacuum mBar*	Sound dB(A)	Height	Width	Depth	Weight Kg	Inlet & Outlet
083009	11	345-415	25	690	14.43	1200	+155	-185	82	631	570	675	140	4"

PRESSURE PERFORMANCE GRAPH

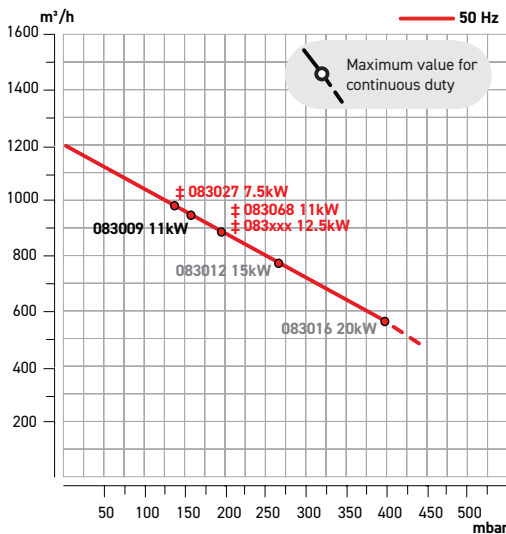

VACUUM PERFORMANCE GRAPH

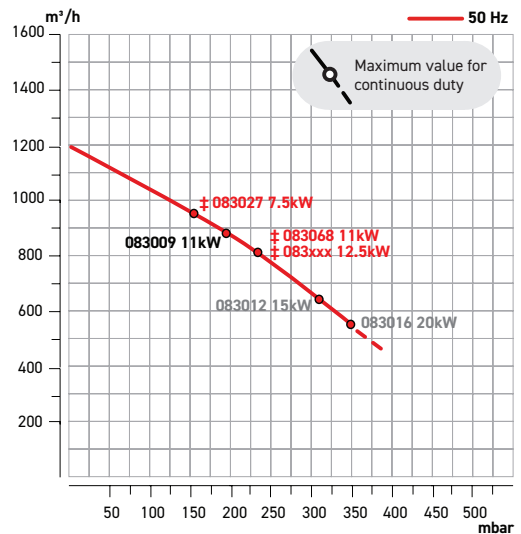

‡ POA/INDEXT

PRESSURE ACCESSORIES

169857	3" Pressure Relief Valve
168537	4" Complete Inlet Filter
167678S	Replacement Cartridge for 4" & 6" Inlet Filter
167678	4" Paper Cartridge Filter for 168537
168537S	4" Complete Inlet Filter with Silencer

VACUUM ACCESSORIES

169844	3" Vacuum Relief Valve
168544	4" Complete Vacuum Filter
167679	4" Replacement Cartridge for 168544

ACCESSORIES - OTHER

169417	4" Barrel Silencer (Threaded in/out end)	169377	4" Barrel Silencer (Threaded in/out end)
1610880	Pressure Gauge 100 KPA/PS		

SERVICE KITS

UNI1000SK	Uni-Jet 1000 3 Phase Major Service Kit
-----------	--

UNI-JET 1000 15

3PH SIDE CHANNEL BLOWER

The UNI-JET 1000 15 side channel blowers is the middle size kilowatt system of the 1000 series and is designed for durability and to operate 24 hours a day at maximum output.



DETAILS THAT MATTER

- » Proven design for longevity
- » Designed to operate 24/7
- » High-quality build

5 YEARS WARRANTY

LOW NOISE & VIBRATION

IP55

MADE IN ITALY

24 CONTINUOUS DUTY RATED 7

THERMAL SENSOR

INVERTER COMPATIBLE

TECHNICAL DATA		UNI-JET 1000 15												
Item Code	kW	Δ Delta Volt	Δ Delta Amp	Y Star Volt	Y Star Amp	Max. Air Flow m³/hr*	Max. Pressure mBar*	Max. Vacuum mBar*	Sound dB(A)	Height	Width	Depth	Weight Kg	Inlet & Outlet
083012	15	345-415	33.2	690	19.17	1200	+265	-315	82	631	570	675	155	4"

PRESSURE PERFORMANCE GRAPH

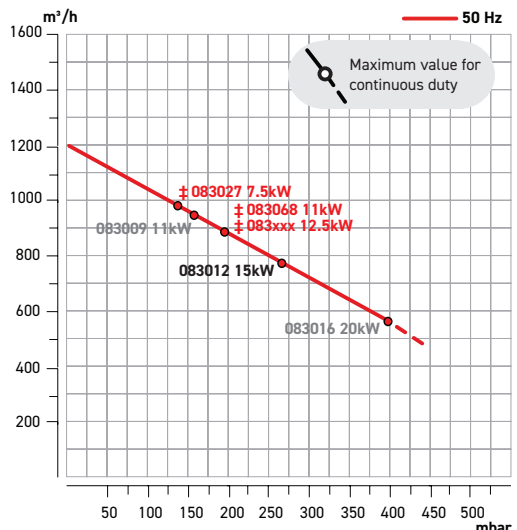

VACUUM PERFORMANCE GRAPH

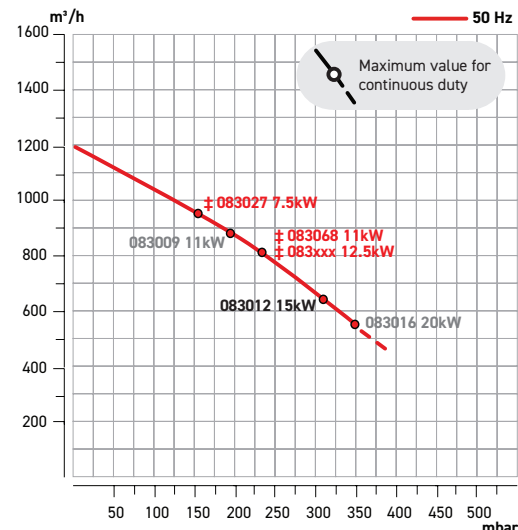

‡ POA/INIDENT

PRESSURE ACCESSORIES

169857	3" Pressure Relief Valve
168537	4" Complete Inlet Filter
167678S	Replacement Cartridge for 4" & 6" Inlet Filter
167678	4" Paper Cartridge Filter for 168537
168537S	4" Complete Inlet Filter with Silencer

VACUUM ACCESSORIES

169844	3" Vacuum Relief Valve
168544	4" Complete Vacuum Filter
167679	4" Replacement Cartridge for 168544

ACCESSORIES - OTHER

169417	4" Barrel Silencer (Threaded in/out end)	169377	4" Barrel Silencer (Threaded in/out end)
1610880	Pressure Gauge 100 KPA/PS		

SERVICE KITS

UNI1000SK	Uni-Jet 1000 3 Phase Major Service Kit
-----------	--

UNI-JET 1000 20

3PH SIDE CHANNEL BLOWER

The UNI-JET 1000 20 delivers a maximum air flow of 1,200m³/hr. ESAM side channel blowers are designed to perform at a high level of precision and durability, operating 24 hours a day at maximum output.



DETAILS THAT MATTER

- » Proven design for longevity
- » Designed to operate 24/7
- » High-quality build



TECHNICAL DATA

UNI-JET 1000 20

Item Code	kW	Δ Delta Volt	Δ Delta Amp	Y Star Volt	Y Star Amp	Max. Air Flow m ³ /hr*	Max. Pressure mBar*	Max. Vacuum mBar*	Sound dB(A)	Height	Width	Depth	Weight Kg	Inlet & Outlet
083016	20	345-415	44.3	690	25.58	1200	+390	-345	82	631	570	719	180	4"

PRESSURE PERFORMANCE GRAPH

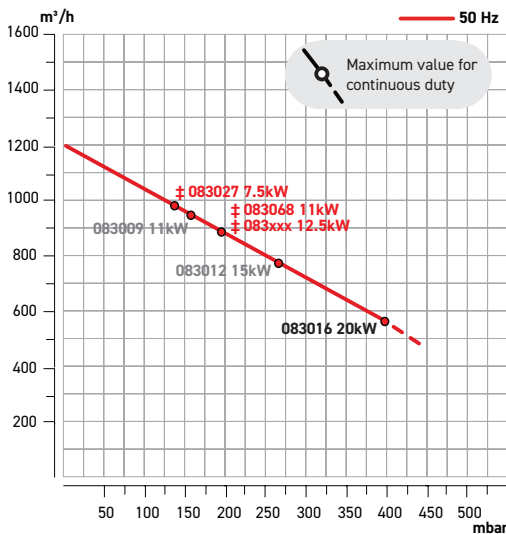

VACUUM PERFORMANCE GRAPH

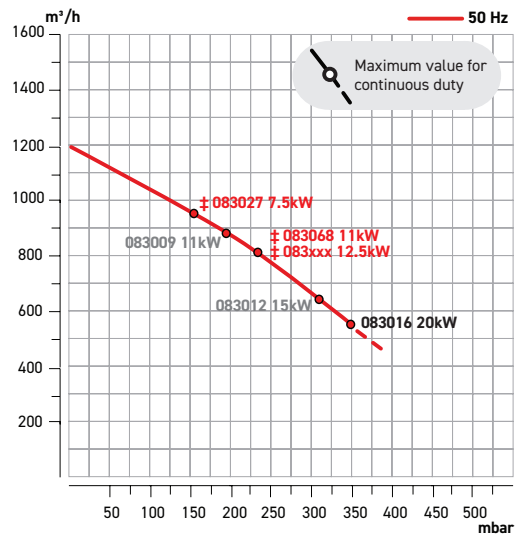

‡ POA/INDEXT

PRESSURE ACCESSORIES

169857	3" Pressure Relief Valve
168537	4" Complete Inlet Filter
167678S	Replacement Cartridge for 4" & 6" Inlet Filter
167678	4" Paper Cartridge Filter for 168537
168537S	4" Complete Inlet Filter with Silencer

VACUUM ACCESSORIES

169844	3" Vacuum Relief Valve
168544	4" Complete Vacuum Filter
167679	4" Replacement Cartridge for 168544

ACCESSORIES - OTHER

169417	4" Barrel Silencer (Threaded in/out end)	169377	4" Barrel Silencer (Threaded in/out end)
1610880	Pressure Gauge 100 KPA/PS		

SERVICE KITS

UNI1000SK	Uni-Jet 1000 3 Phase Major Service Kit
-----------	--

UNI-JET 1500 15

3PH SIDE CHANNEL BLOWER

Moving into the 1,500m³/hr maximum air flow range the UNI-JET 1500 series is available in a 15 or 20kW configuration depending on your pressure or vacuum requirements.

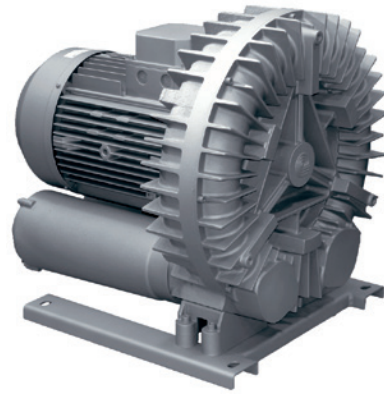

DETAILS THAT MATTER

- » Low maintenance
- » High air flow
- » Tested to perform 24/7

5 YEARS WARRANTY

LOW NOISE & VIBRATION

IP55

MADE IN ITALY

24 CONTINUOUS DUTY RATED 7

THERMAL SENSOR

INVERTER COMPATIBLE

TECHNICAL DATA											UNI-JET 1500 15			
Item Code	kW	Δ Delta Volt	Δ Delta Amp	Y Star Volt	Y Star Amp	Max. Air Flow m ³ /hr*	Max. Pressure mBar*	Max. Vacuum mBar*	Sound dB(A)	Height	Width	Depth	Weight Kg	Inlet & Outlet
084000	15	345-415	33.2	690	19.17	1500	+210	-225	82	633	570	659	156	4"

PRESSURE PERFORMANCE GRAPH

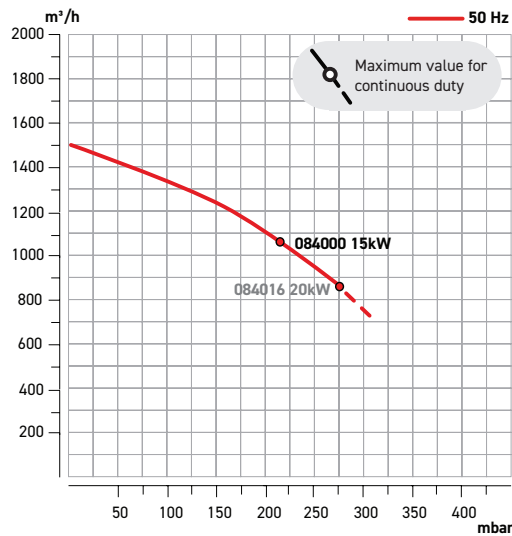

VACUUM PERFORMANCE GRAPH

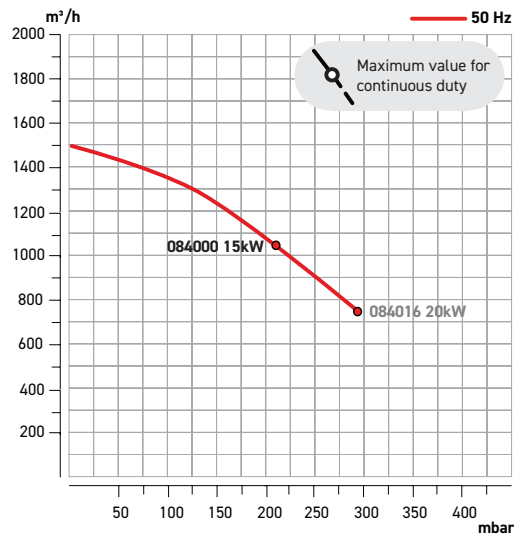

PRESSURE ACCESSORIES

169857 (x2)	3" Pressure Relief Valve
168537	4" Complete Inlet Filter
167678S	Replacement Cartridge for 4" & 6" Inlet Filter
167678	4" Paper Cartridge Filter for 168537
168537S	4" Complete Inlet Filter with Silencer

VACUUM ACCESSORIES

169844 (x2)	3" Vacuum Relief Valve
168544	4" Complete Vacuum Filter
167679	4" Replacement Cartridge for 168544

ACCESSORIES - OTHER

1610880	Pressure Gauge 100 KPA/PS
---------	---------------------------

SERVICE KITS

UNI1500SK	Uni-Jet 1500 3 Phase Major Service Kit
-----------	--

UNI-JET 1500 20

3PH SIDE CHANNEL BLOWER

Delivering 1,500m³/hr maximum air flow range the UNI-JET 1500 20 is the larger kilowatt system in the range delivering higher pressure or vacuum performance. Designed to give performance at a higher air flow.

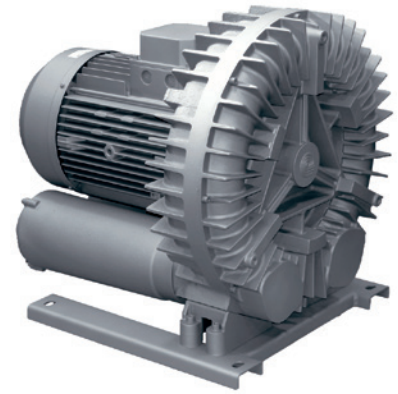

DETAILS THAT MATTER

- » Low maintenance
- » High air flow
- » Tested to perform 24/7



TECHNICAL DATA

UNI-JET 1500 20

Item Code	kW	Δ Delta Volt	Δ Delta Amp	Y Star Volt	Y Star Amp	Max. Air Flow m ³ /hr*	Max. Pressure mBar*	Max. Vacuum mBar*	Sound dB(A)	Height	Width	Depth	Weight Kg	Inlet & Outlet
084016	20	345-415	44.3	690	25.58	1500	+295	-295	82	633	570	703	181	4"

PRESSURE PERFORMANCE GRAPH

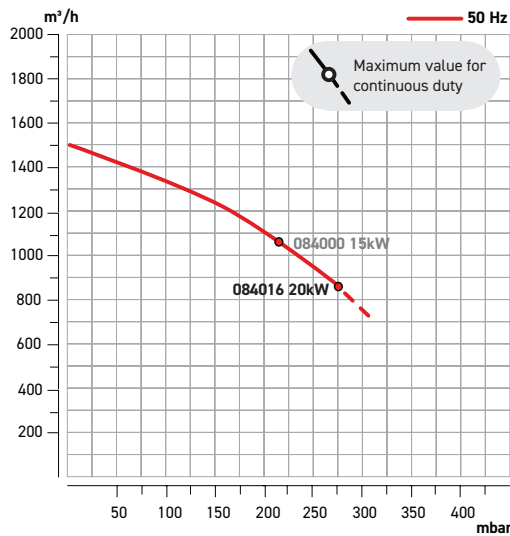

VACUUM PERFORMANCE GRAPH

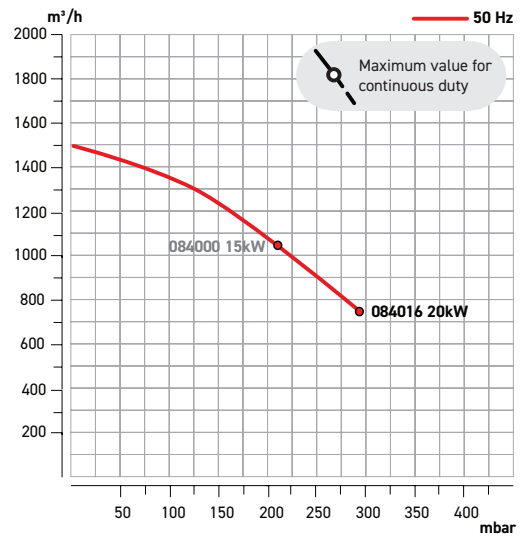

PRESSURE ACCESSORIES

169857 (x2)	3" Pressure Relief Valve
168537	4" Complete Inlet Filter
167678S	Replacement Cartridge for 4" & 6" Inlet Filter
167678	4" Paper Cartridge Filter for 168537
168537S	4" Complete Inlet Filter with Silencer

VACUUM ACCESSORIES

169844 (x2)	3" Vacuum Relief Valve
168544	4" Complete Vacuum Filter
167679	4" Replacement Cartridge for 168544

ACCESSORIES - OTHER

1610880	Pressure Gauge 100 KPA/PS
---------	---------------------------

SERVICE KITS

UNI1500SK	Uni-Jet 1500 3 Phase Major Service Kit
-----------	--

UNI-JET 2200

3PH SIDE CHANNEL BLOWER

Delivering a maximum air flow of 2,200m³/hr the UNI-JET 2200 is the largest of our UNI-JET series. When high air flow requirements are necessary for success, the UNI-JET 2200 is the side channel blower of choice.

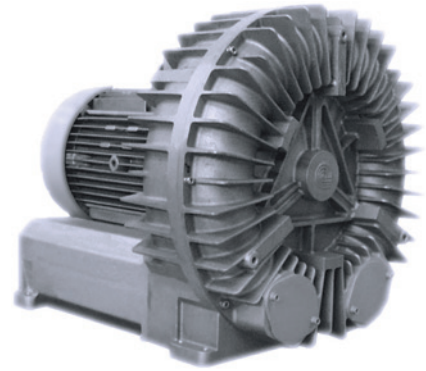

DETAILS THAT MATTER

- » Low maintenance
- » Rigorously tested to extremes
- » High air flow



TECHNICAL DATA											UNI-JET 2200			
Item Code	kW	Δ Delta Volt	Δ Delta Amp	Y Star Volt	Y Star Amp	Max. Air Flow m ³ /hr*	Max. Pressure mBar*	Max. Vacuum mBar*	Sound dB(A)	Height	Width	Depth	Weight Kg	Inlet & Outlet
087009	20	345-415	44.3	690	25.58	2200	+130	-185	82	610	600	739	166	D.145

PRESSURE PERFORMANCE GRAPH

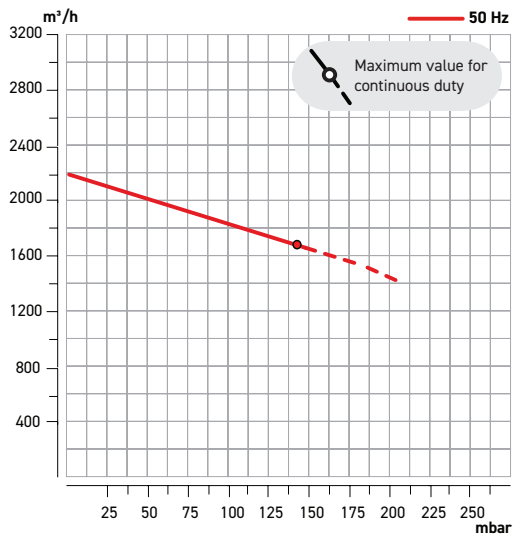

VACUUM PERFORMANCE GRAPH

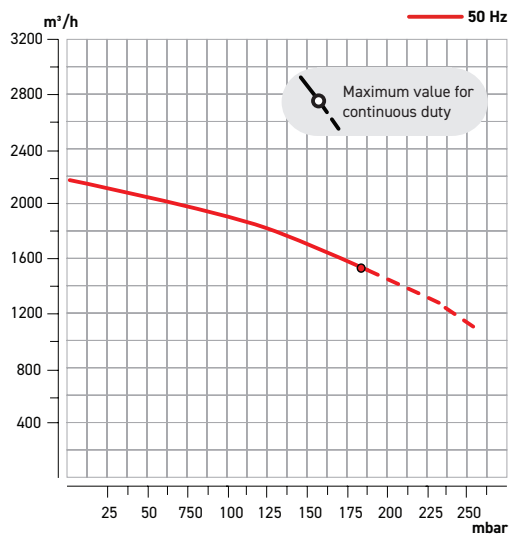

PRESSURE ACCESSORIES

169857 (2x)	3" Pressure Relief Valve
168419	6" Complete Inlet Filter & Suction Filter
167678S	Replacement Cartridge for 4" & 6" Inlet Filter
168444	6" Paper Cartridge Filter for 168419
168538S	6" Complete Inlet Filter with Silencer

VACUUM ACCESSORIES

169844 (2x)	3" Vacuum Relief Valve
168419	6" Complete Inlet Filter & Suction Filter
168444	6" Paper Cartridge Filter for 168419

ACCESSORIES - OTHER

169776	Tubeholder Flange Kit D150	169382	Barrel Silencer (Threaded in/out end)
1610880	Pressure Gauge 100 KPA/PS		

SERVICE KITS

UNI2200SK	Uni-Jet 2200 3 Phase Major Service Kit
-----------	--

SINGLE PHASE

SIDE CHANNEL BLOWERS



ESAM's single-phase side channel blowers emerge as champions of efficiency and compact power. Be it light commercial or residential, these agile units are meticulously designed to infuse smaller scale operations, delivering reliable airflow. Whether providing a balance of aeration, or supporting vacuum applications, these units pledge quality and reliability. Crafted for the seamless integration into spaces where three-phase power is beyond reach, they embody the ESAM legacy of excellence, ensuring no compromise on performance.

UNI-JET 40 SP

1 PH SIDE CHANNEL BLOWER

The UNI-JET 40 SP is the smallest of the ESAM UNI-JET single phase series of side channel blowers that delivers a maximum air flow of 40 m³/hr.



DETAILS THAT MATTER

- » Dynamically balanced
- » Low maintenance
- » Continuous operation 24/7



TECHNICAL DATA

UNI-JET 40 SP

Item Code	kW	Volt	Amp	Max. Air Flow m ³ /hr*	Max. Pressure mBar*	Max. Vacuum mBar*	Sound dB(A)	Height	Width	Depth	Weight Kg	Inlet & Outlet
014011	0.2	230	2	40	+90	-80	-	219	198	220		1"

PRESSURE PERFORMANCE GRAPH

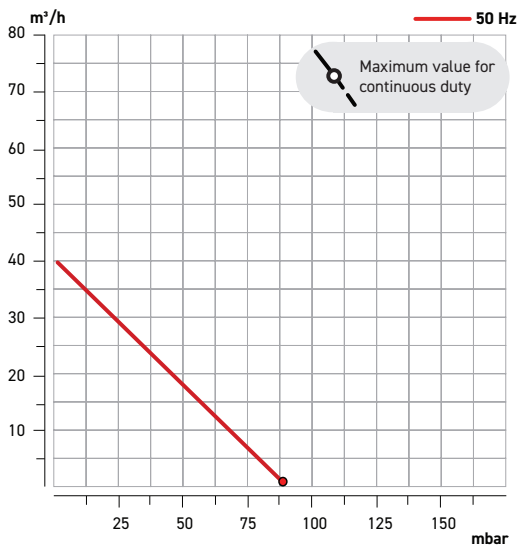

VACUUM PERFORMANCE GRAPH

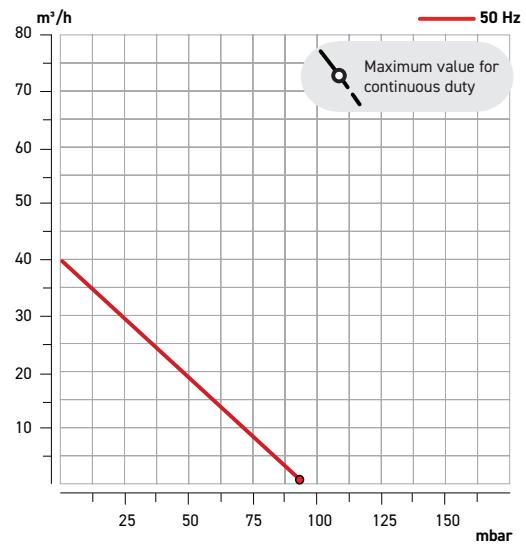

PRESSURE ACCESSORIES

168554	1" Mesh Inlet Filter
168410	1" Complete Inlet Filter
168530S	1" Complete Inlet Filter with Silencer
167690	1" & 1¼" Polyester Cartridge Filter for 168410 & 168411

VACUUM ACCESSORIES

168410	1" Complete Inlet Filter
167690	1" & 1¼" Polyester Cartridge Filter for 168410 & 168411
168410S	1" Complete Inlet Filter with Silencer

ACCESSORIES - OTHER

169769	¾" Threaded Flange Kit screws and gasket	169766	Tubeholder Flange Kit D30
169752C	1" Threaded Flange Kit screws and gasket	EF15A0	Power Plug Connection, Test & Tag - 1.5mm Flex + 10A Plug Rear Entry Grey 1.5m
1610880	Pressure Gauge 100 KPA/PS		

SERVICE KITS

Upon Request

† INDENT † POA - REFER APPENDIX

UNI-JET 75

1PH SIDE CHANNEL BLOWER

The UNI-JET 75 is the most popular of the ESAM single phase range of side channel blowers. This model is ideal for aquatic applications.



DETAILS THAT MATTER

- » Ideal spa side channel blower
- » Low maintenance
- » Rigorously tested to extremes



TECHNICAL DATA											UNI-JET 75	
Item Code	kW	Volt	Amp	Max. Air Flow m ³ /hr*	Max. Pressure mBar*	Max. Vacuum mBar*	Sound dB(A)	Height	Width	Depth	Weight Kg	Inlet & Outlet
015025	0.4	230	3.1	80	+145	-145	62	251	245.5	231	10	1 1/4"

PRESSURE PERFORMANCE GRAPH

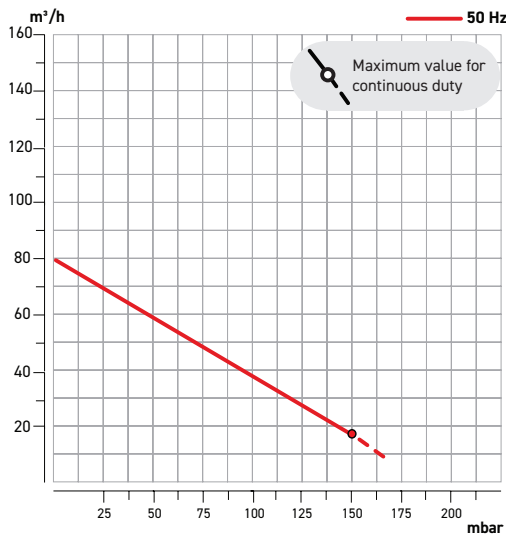

VACUUM PERFORMANCE GRAPH

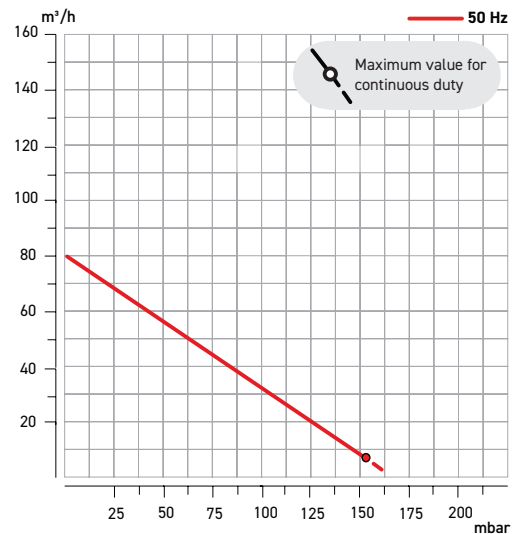

PRESSURE ACCESSORIES

169886	1 1/2" Pressure Relief Valve
168550	1 1/4" Mesh Inlet Filter
168411	1 1/4" Complete Inlet Filter
168552S	1 1/4" Complete Inlet Filter with Silencer
167682	1 1/4" & 1 1/2" Element Polyester Inlet Filter for 168552S, 168554S and 168412L
167690	1" & 1 1/4" Polyester Cartridge Filter for 168410 & 168411

VACUUM ACCESSORIES

169885	1 1/2" Vacuum Relief Valve
168560	1 1/4" Complete Vacuum Filter
167671	1 1/4" Replacement Cartridge for 168560

ACCESSORIES - OTHER

169411	1 1/4" Barrel Silencer (Threaded Single End)	1610880	Pressure Gauge 100 KPA/PS
169384	1 1/4" Barrel Silencer (Threaded in/out)	EF15A0	Power Plug Connection, Test & Tag - 1.5mm Flex + 10A Plug Rear Entry Grey 1.5m
169750C	Uni-Jet 75 & 75 2V Threaded Flange Kit		

SERVICE KITS

UNISK1	Uni-Jet 75 Single Phase - 5 Year Service Kit
--------	--

1PH SIDE CHANNEL BLOWERS

UNI-JET 75 cCSAUS

1 PH SIDE CHANNEL BLOWER



The UNI-JET 75 cCSAUS is certified cCSAus. This side channel blower delivers a maximum air flow of 80m³/hr, all in a compact footprint.



DETAILS THAT MATTER

- » Low maintenance
- » Rigorously tested to extremes
- » Dual Voltage | Dual Frequency (50/60Hz)



1PH SIDE CHANNEL BLOWERS

TECHNICAL DATA UNI-JET 75 cCSAUS

Item Code	kW	Volt	Amp	Max. Air Flow m ³ /hr*	Max. Pressure mBar*	Max. Vacuum mBar*	Sound dB(A)	Height	Width	Depth	Weight Kg	Inlet & Outlet
015198	0.4	230 50Hz	6-3	80	+147	-147	62	252	246	271	10	1 1/4"
015198	0.5	115 60Hz	7-3.6	95	+132	-137	63	252	246	271	10	1 1/4"

PRESSURE PERFORMANCE GRAPH

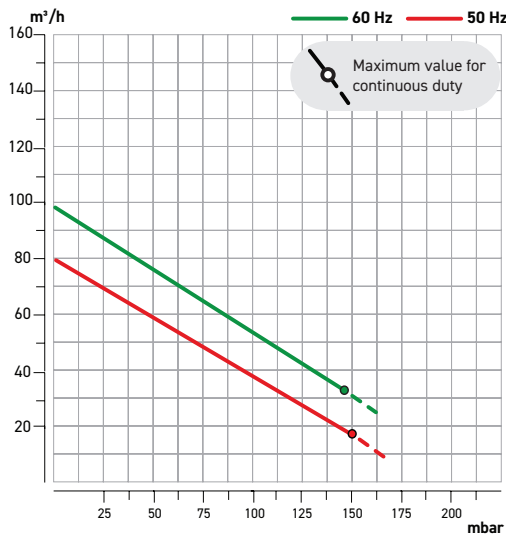

VACUUM PERFORMANCE GRAPH

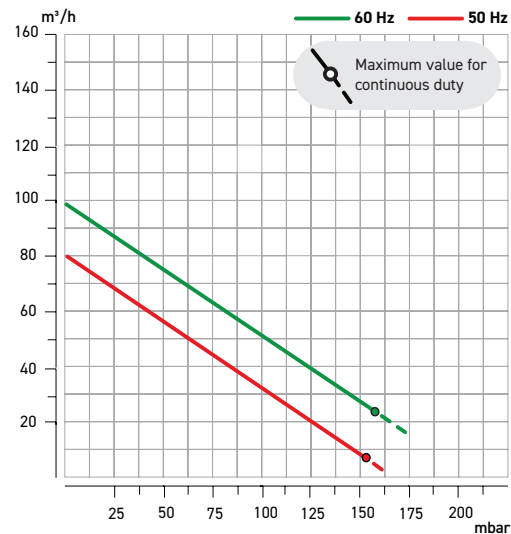

PRESSURE ACCESSORIES

169886	1 1/2" Pressure Relief Valve
168550	1 1/4" Mesh Inlet Filter
168411	1 1/4" Complete Inlet Filter
168552S	1 1/4" Complete Inlet Filter with Silencer
167682	1 1/4" & 1 1/2" Polyester Cartridge Filter for 168552S, 168554S and 168412L
167690	1" & 1 1/4" Polyester Cartridge Filter for 168410 & 168411

VACUUM ACCESSORIES

169885	1 1/2" Vacuum Relief Valve
168560	1 1/4" Complete Vacuum Filter
167671	1 1/4" Replacement Cartridge for 168560

ACCESSORIES - OTHER

169411	1 1/4" Barrel Silencer (Threaded Single End)	1610880	Pressure Gauge 100 KPA/PS
169384	1 1/4" Barrel Silencer (Threaded in/out)	EF15A0	Power Plug Connection, Test & Tag - 1.5mm Flex + 10A Plug Rear Entry Grey 1.5m
169750C	Uni-Jet 75 & 75 2V Threaded Flange Kit		

SERVICE KITS

UNISK1	Uni-Jet 75 Single Phase - 5 Year Service Kit
--------	--

TECNO-JET IIS

1PH SIDE CHANNEL BLOWER

The TECNO-JET IIS delivers a maximum pressure of +135mBar or a maximum vacuum of -135mBar.

DETAILS THAT MATTER

- » Low maintenance
- » Rigorously tested to extremes



TECHNICAL DATA						TECNO-JET IIS						
Item Code	kW	Volt	Amp	Max. Air Flow m ³ /hr*	Max. Pressure mBar*	Max. Vacuum mBar*	Sound dB(A)	Height	Width	Depth	Weight Kg	Inlet & Outlet
046759	0.75	230	5.5	135	+135	-135	68	319	302.5	302	18	1½"

PRESSURE PERFORMANCE GRAPH

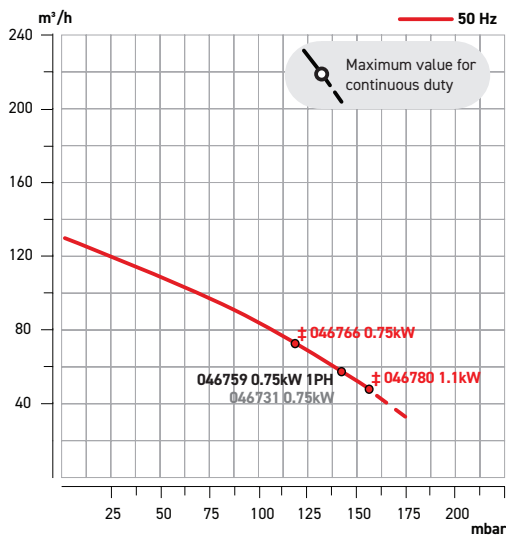

VACUUM PERFORMANCE GRAPH

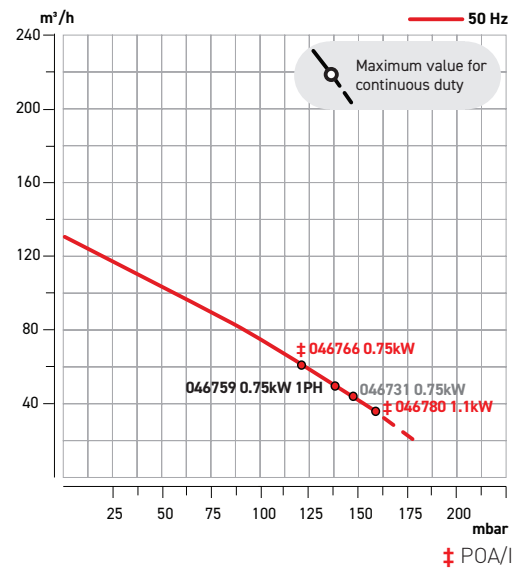

PRESSURE ACCESSORIES

169886	1½" Pressure Relief Valve
168553	1½" Mesh Inlet Filter
168412	1½" Complete Inlet Filter
167682	1¼" & 1½" Element Polyester Inlet Filter for 168552S, 168554S and 168412L
167691	1½" Polyester Cartridge Filter for 168412
168554S	1½" Complete Inlet Filter with Silencer

VACUUM ACCESSORIES

169885	1½" Vacuum Relief Valve
168564	1½" Complete Vacuum Filter
167673	1½" Replacement Cartridge for 168564

ACCESSORIES - OTHER

169410	1½" Barrel Silencer (Threaded Single End)	1610880	Pressure Gauge 100 KPA/PS
169385	1½" Barrel Silencer (Threaded in/out)	EF15A0	Power Plug Connection, Test & Tag - 1.5mm Flex + 10A Plug Rear Entry Grey 1.5m

SERVICE KITS

TECSK1	Tecno-Jet 1 Phase - 5 Year Service Kit
--------	--

UNI-JET 75 2V

1 PH SIDE CHANNEL BLOWER

When higher pressure is critical the ESAM range of 2V side channel blowers are perfect. The UNI-JET 75 2V is designed to deliver a higher pressure of a maximum 245mBar.

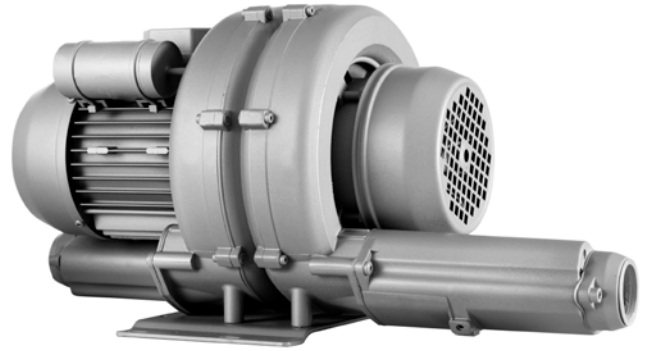

DETAILS THAT MATTER

- » Higher pressure performance
- » Low maintenance
- » Rigorously tested to extremes

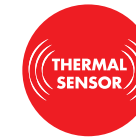

TECHNICAL DATA

UNI-JET 75 2V

Item Code	kW	Volt	Amp	Max. Air Flow m ³ /hr*	Max. Pressure mBar*	Max. Vacuum mBar*	Sound dB(A)	Height	Width	Depth	Weight Kg	Inlet & Outlet
019120	0.8	230	4.8	80	+245	-270	64	251	245.5	489	16	1¼"

PRESSURE PERFORMANCE GRAPH

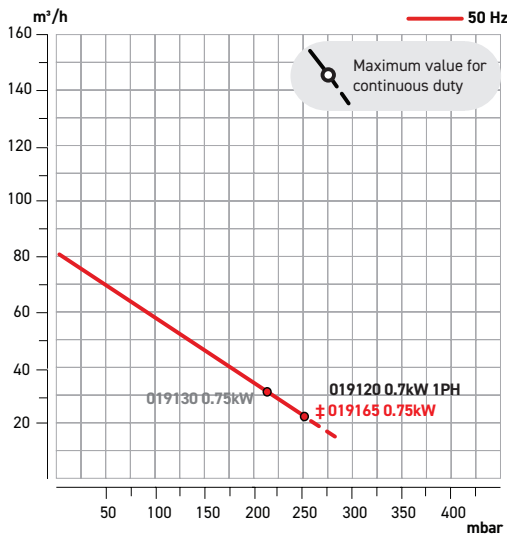

VACUUM PERFORMANCE GRAPH

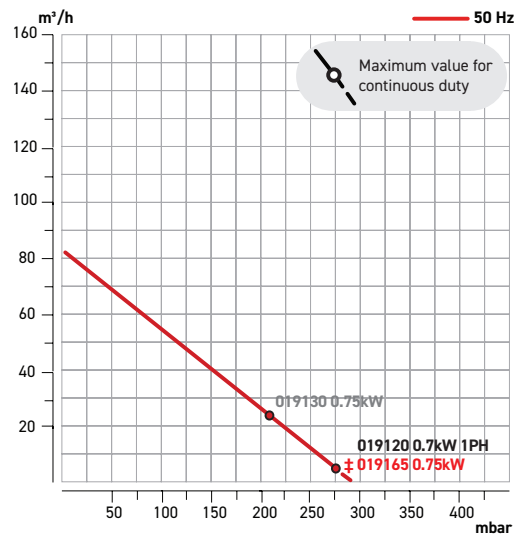

‡ POA/INDEPENDENT

PRESSURE ACCESSORIES

169886	1½" Pressure Relief Valve
168411	1¼" Complete Inlet Filter
168411L	1¼" Complete Inlet Filter
168552S	1¼" Complete Inlet Filter with Silencer
167682	1¼" & 1½" Polyester Cartridge Filter for 168552S, 168554S and 168412L
167690	1" & 1¼" Polyester Cartridge Filter for 168410 & 168411

VACUUM ACCESSORIES

169885	1½" Vacuum Relief Valve
168560	1¼" Complete Vacuum Filter
167671	1¼" Replacement Cartridge for 168560

ACCESSORIES - OTHER

169411	1¼" Barrel Silencer (Threaded Single End)	1610880	Pressure Gauge 100 KPA/PS
169384	1¼" Barrel Silencer (Threaded in/out)	EF15A0	Power Plug Connection, Test & Tag - 1.5mm Flex + 10A Plug Rear Entry Grey 1.5m
169750C	1¼" Threaded Flange Kit		

SERVICE KITS

UNI2VSK1	Uni-Jet 75 2V 1 Phase Service Kit
----------	-----------------------------------

FLUX-JET 1.1

1PH SIDE CHANNEL BLOWER

The FLUX-JET 1.1 is an ideal choice for aquatic applications such as spas. One of the more popular models in the ESAM single phase range of side channel blowers when higher air flow is required to power spa jets.



DETAILS THAT MATTER

- » Ideal spa side channel blower
- » Low maintenance
- » Rigorously tested to extremes



TECHNICAL DATA						FLUX-JET 1.1						
Item Code	kW	Volt	Amp	Max. Air Flow m ³ /hr*	Max. Pressure mBar*	Max. Vacuum mBar*	Sound dB(A)	Height	Width	Depth	Weight Kg	Inlet & Outlet
048137	1.1	230	7.6	200	+145	-145	68	341	334	283	21	1½"

PRESSURE PERFORMANCE GRAPH

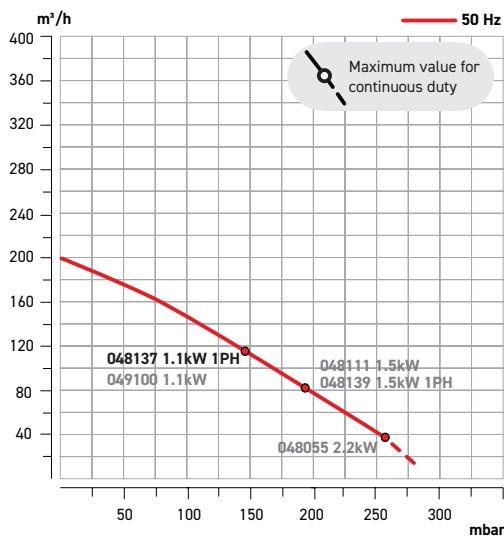

VACUUM PERFORMANCE GRAPH

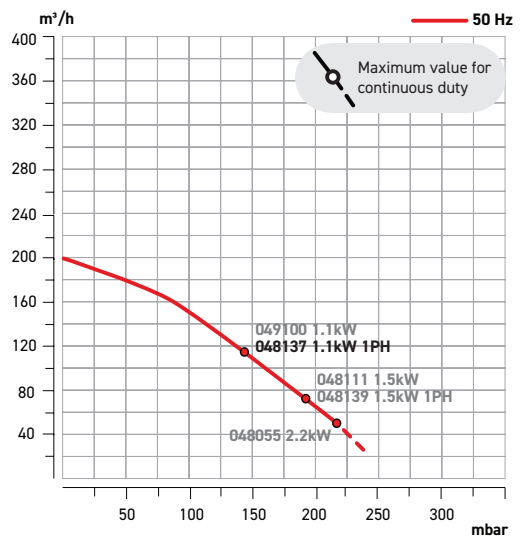

PRESSURE ACCESSORIES

169886	1½" Pressure Relief Valve
168553	1½" Mesh Inlet Filter
168412	1½" Complete Inlet Filter
167682	1¼" & 1½" Element Polyester Inlet Filter for 168552S, 168554S and 168412L
167691	1½" Polyester Cartridge Filter for 168412
168554S	1½" Complete Inlet Filter with Silencer
167682	1¼" & 1½" Polyester Cartridge Filter

VACUUM ACCESSORIES

169885	1½" Vacuum Relief Valve
168564	1½" Complete Vacuum Filter
167673	1½" Replacement Cartridge for 168564
168564L	1½" Complete Vacuum Filter

ACCESSORIES - OTHER

169410	1½" Barrel Silencer (Threaded Single End)	1610880	Pressure Gauge 100 KPA/PS
169385	1½" Barrel Silencer (Threaded in/out)	EF15A0	Power Plug Connection, Test & Tag - 1.5mm Flex + 10A Plug Rear Entry Grey 1.5m
169770C	1½" Flux-Jet Threaded Flange Kit		

SERVICE KITS

FLUSK1	Flux-Jet 1 Phase - 5 Years Service Kit
--------	--

FLUX-JET 1.5

1PH SIDE CHANNEL BLOWER

The FLUX-JET 1.5 is the step up from the FLUX-JET 1.1 and is the go to choice when additional pressure is required. This model is extremely popular for aquatic applications.



DETAILS THAT MATTER

- » Ideal spa side channel blower
- » Low maintenance
- » Rigorously tested to extremes

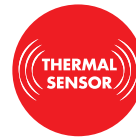

TECHNICAL DATA

FLUX-JET 1.5

Item Code	kW	Volt	Amp	Max. Air Flow m ³ /hr*	Max. Pressure mBar*	Max. Vacuum mBar*	Sound dB(A)	Height	Width	Depth	Weight Kg	Inlet & Outlet
048139	1.5	230	10	200	+185	-185	68	341	334	283	21	1½"

PRESSURE PERFORMANCE GRAPH

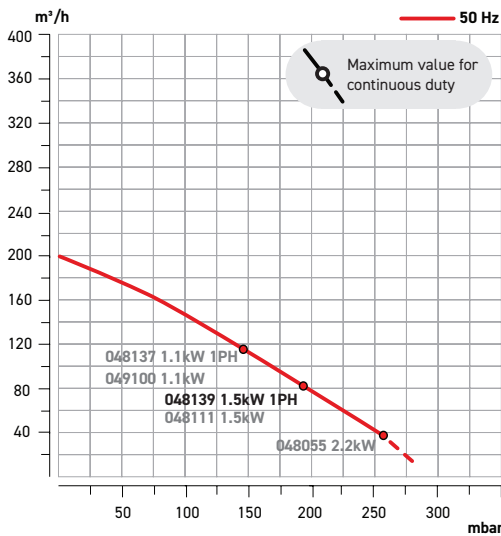

VACUUM PERFORMANCE GRAPH

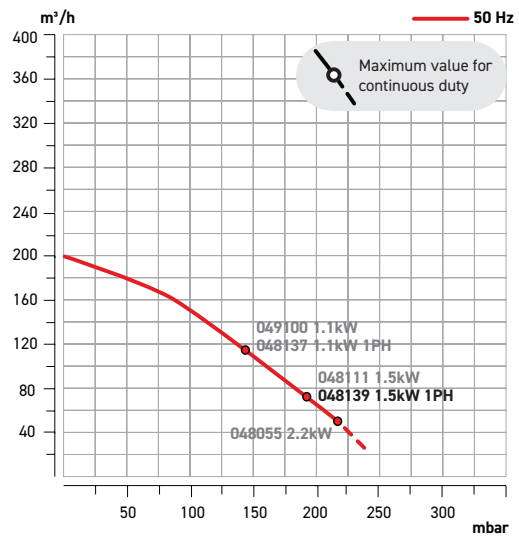

PRESSURE ACCESSORIES

169886	1½" Pressure Relief Valve
168553	1½" Mesh Inlet Filter
168412	1½" Complete Inlet Filter
168554S	1½" Complete Inlet Filter with Silencer
167691	1½" Polyester Cartridge Filter for 168412
167682	Element Polyester 1.5in & 1.25in Inlet Filter for 168552S, 168554S and 168412L

VACUUM ACCESSORIES

169885	1½" Vacuum Relief Valve
168564	1½" Complete Vacuum Filter
168564L	1½" Complete Vacuum Filter
167673	1½" Replacement Cartridge for 168564

ACCESSORIES - OTHER

169410	1½" Barrel Silencer (Threaded Single End)	1610880	Pressure Gauge 100 KPA/PS
169385	1½" Barrel Silencer (Threaded in/out)	EF15A0	Power Plug Connection, Test & Tag - 1.5mm Flex + 10A Plug Rear Entry Grey 1.5m
169770C	1½" Flux-Jet Threaded Flange Kit		

SERVICE KITS

FLUSK1	Flux-Jet 1 Phase - 5 Years Service Kit
--------	--

1PH SIDE CHANNEL BLOWERS

MEDIO-JET CE

1PH SIDE CHANNEL BLOWER

The MEDIO-JET CE is the largest of the single phase range of side channel blowers at 2kW. It delivers an impressive maximum air flow of 330m³/hr.



DETAILS THAT MATTER

- » Continuous operation 24/7
- » Low maintenance
- » Rigorously tested to extremes



TECHNICAL DATA						MEDIO-JET CE						
Item Code	kW	Volt	Amp	Max. Air Flow m ³ /hr*	Max. Pressure mBar*	Max. Vacuum mBar*	Sound dB(A)	Height	Width	Depth	Weight Kg	Inlet & Outlet
061657	2	240	12.5	330	+160	-170	71	415	395	332	34	2"

PRESSURE PERFORMANCE GRAPH

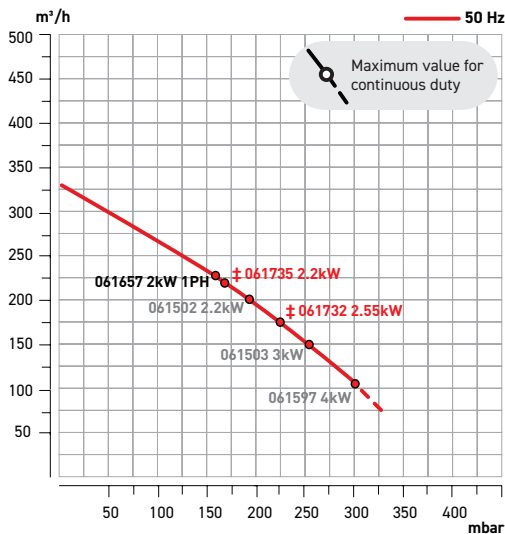

VACUUM PERFORMANCE GRAPH

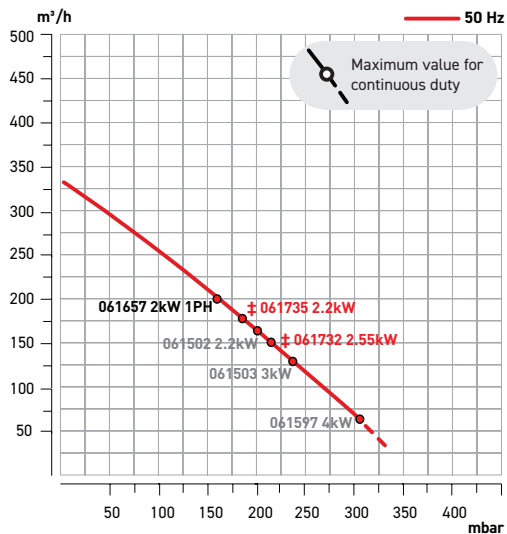

PRESSURE ACCESSORIES

169858	2" Pressure Relief Valve
168555	2" Mesh Inlet Filter
168491	2" Complete Inlet Filter
168556S	2" Complete Inlet Filter with Silencer
167692	2" Polyester Cartridge Filter for 168491
167670S	2" & 2½" Polyester Inlet Filter S Type

VACUUM ACCESSORIES

169846	2" Vacuum Relief Valve
168561	2" Complete Vacuum Filter
167672	2" & 2½" Replacement Cartridge for 168561 & 168543

ACCESSORIES - OTHER

169413	2" Barrel Silencer (Threaded in/out)	169751C	Medio-Jet, 1AC & 2V Threaded Flange Kit
169372	2" Barrel Silencer (Threaded single end)	EF15AT0	Power Plug Connection, Test & Tag - 1.5mm Flex + 15A Plug Rear Entry Grey 1.5m
1610880	Pressure Gauge 100 KPA/PS	169412	2" Barrel Silencer (Threaded in/out)

SERVICE KITS

MEDSK1	Medio-Jet 1 Phase - 5 Years Service Kit
--------	---

1PH SIDE CHANNEL BLOWERS

ACCESSORIES

SIDE CHANNEL BLOWERS

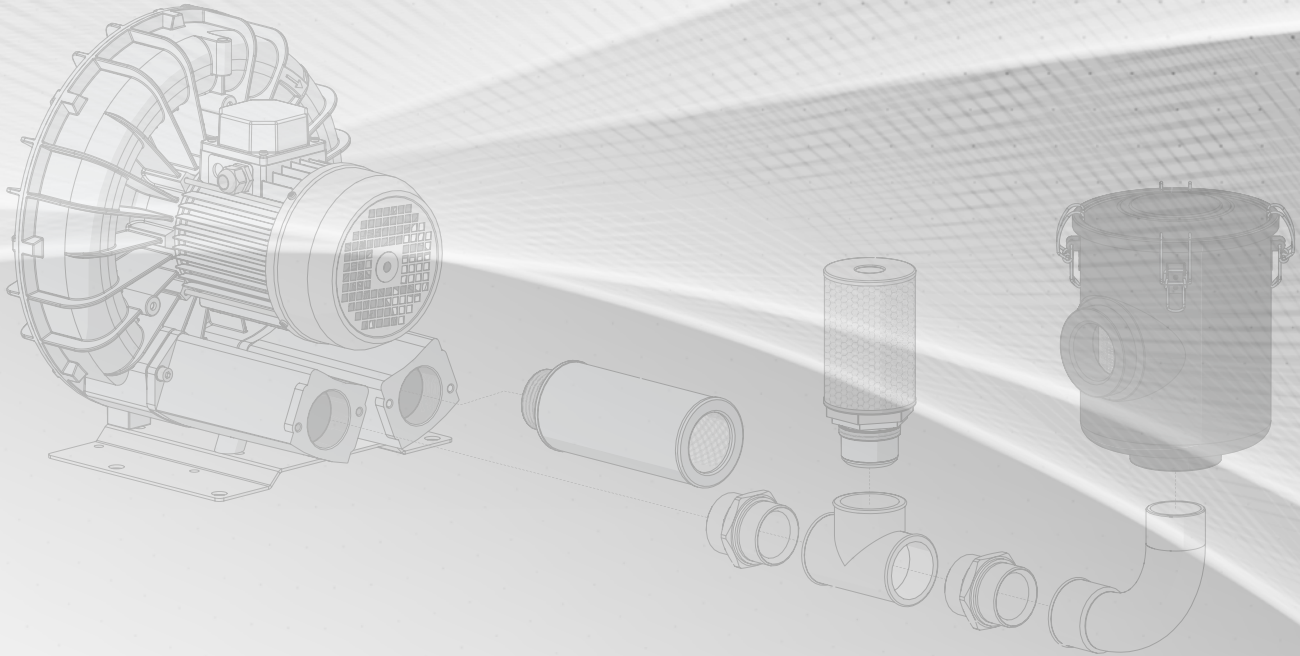

ESAM offers a comprehensive range of accessories, crafted to ensure the reliable performance of our side channel blowers. From specially designed filters to vacuum/pressure relief valves, these essential accessories are designed to ensure peak performance, thereby safeguarding your warranty. Rigorously tested for compatibility, each component underscores our commitment to “QUALITY COMES FIRST,” ensuring your ESAM blower operates at its best.

PRESSURE INSTALLATION ACCESSORIES EXAMPLE

SINGLE-STAGE SIDE CHANNEL BLOWER

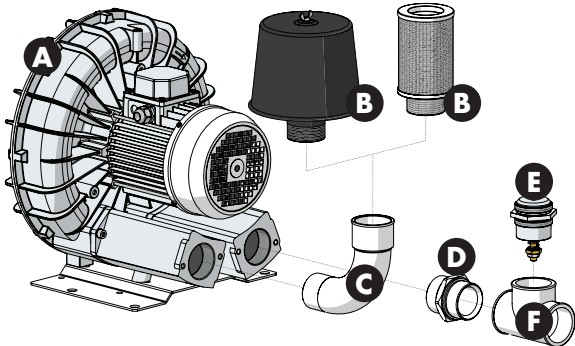

TWO-STAGE SIDE CHANNEL BLOWER

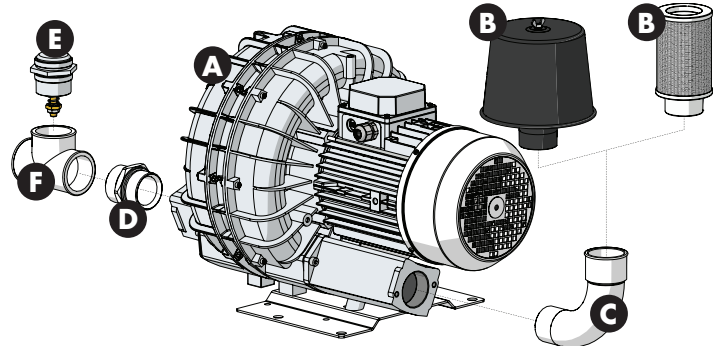

- A** Side Channel Blower **B** Inlet Filter & Element **C** Elbow Fitting **D** Nipple **E** Pressure Relief Valve **F** T-Piece

IMPORTANT!

Installation of a filter and pressure relief valve is required for installation.
FAILURE to do so will void your warranty.

VACUUM INSTALLATION ACCESSORIES EXAMPLE

SINGLE-STAGE SIDE CHANNEL BLOWER

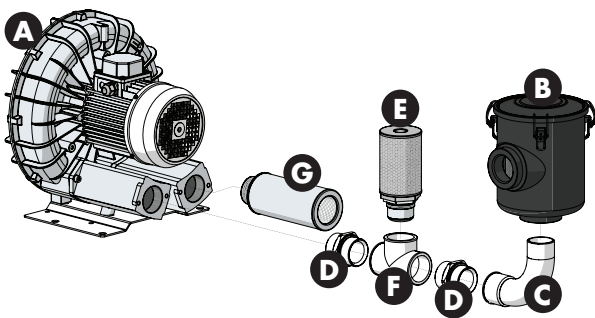

TWO-STAGE SIDE CHANNEL BLOWER

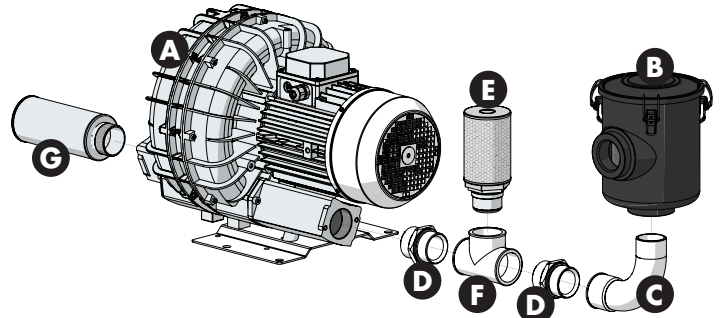

- A** Side Channel Blower **B** Inlet Filter & Element **C** Elbow Fitting **D** Nipple **E** Vacuum Relief Valve
F T-Piece **G** Silencer

IMPORTANT!

Installation of a filter and vacuum relief valve is required for installation.
FAILURE to do so will void your warranty.

ACCESSORIES

SIDE CHANNEL BLOWERS



Go to **PAGE 57** for accessory line drawings.

TECHNICAL DATA			PRESSURE RELIEF VALVE							
Item Code	Name	Product Suitability	A	B	C	D	E	F	G	H
169886	1½" Pressure Relief Valve	<ul style="list-style-type: none"> Uni-Jet 75 Uni-Jet 75 2V Tecno-Jet Tecno-Jet 2V Flux-Jet Flux-Jet 2V 	103	1½"	1½"	CH55	133			
169888	1½" Pressure Relief Valve	<ul style="list-style-type: none"> Uni-Jet 160 	103	1½"	1½"	CH55	133			
169858	2" Pressure Relief Valve	<ul style="list-style-type: none"> Medio-Jet Medio-Jet 2V Medio-Jet 350 Medio-Jet 1AC 	75	2"	2"	CH65	95			
169857	3" Pressure Relief Valve	<ul style="list-style-type: none"> Medio-Jet 1AC Uni-Jet 501 Uni-Jet 501 Uni-Jet 1000 	65	3"F	3"F	CH100	142			
169857 (2x)	3" Pressure Relief Valve	<ul style="list-style-type: none"> Uni-Jet 1500 Uni-Jet 2200 	65	3"F	3"F	CH100	142			

TECHNICAL DATA			VACUUM RELIEF VALVE							
Item Code	Name	Product Suitability	A	B	C	D	E	F	G	H
169885	1½" Vacuum Relief Valve	<ul style="list-style-type: none"> Uni-Jet 75 Uni-Jet 75 2V Tecno-Jet Tecno-Jet 2V Flux-Jet Flux-Jet 2V 	82	80	1½"	CH55	114			
169887	1½" Vacuum Relief Valve	<ul style="list-style-type: none"> Uni-Jet 160 	82	88	1½"	CH55	114			
169846	2" Vacuum Relief Valve	<ul style="list-style-type: none"> Medio-Jet Medio-Jet 2V Medio-Jet 350 Medio-Jet 1AC 	135	80	2"	CH65	195			
169844	3" Vacuum Relief Valve	<ul style="list-style-type: none"> Uni-Jet 501 Uni-Jet 501 Uni-Jet 1000 	138	206	3"	CH100	237			
169844 (2x)	3" Vacuum Relief Valve	<ul style="list-style-type: none"> Uni-Jet 1500 Uni-Jet 2200 	138	206	3"	CH100	237			

TECHNICAL DATA			ONE ENDED SUPPLEMENTARY SILENCER							
Item Code	Name	Product Suitability	A	B	C	D	E	F	G	H
169411	1¼" Barrel Silencer (Threaded Single End)	<ul style="list-style-type: none"> Uni-Jet 75 Uni-Jet 75 2V 	1¼"	36	190	52	138	69		
169410	1½" Barrel Silencer (Threaded Single End)	<ul style="list-style-type: none"> Tecno-Jet Tecno-Jet 2V Flux-Jet Flux-Jet 2V Uni-Jet 160 	1½"	42	200	32	168	80		
169412	2" Barrel Silencer (Threaded Single End)	<ul style="list-style-type: none"> Medio-Jet Medio-Jet 2V Medio-Jet 350 Medio-Jet 1AC 	2"	54	230	32	198	89		
169372	2" Barrel Silencer (Threaded Single End)	<ul style="list-style-type: none"> Medio-Jet Medio-Jet 2V Medio-Jet 350 Medio-Jet 1AC 	2"	54	230	32	198	89		

TECHNICAL DATA			DOUBLE ENDED SUPPLEMENTARY SILENCER							
Item Code	Name	Product Suitability	A	B	C	D	E	F	G	H
169384	1¼" Barrel Silencer (Threaded in/out)	<ul style="list-style-type: none"> Uni-Jet 75 Uni-Jet 75 2V 	1¼"	1¼"	242	52	138	70		
169385	1½" Barrel Silencer (Threaded in/out)	<ul style="list-style-type: none"> Tecno-Jet Tecno-Jet 2V Flux-Jet Flux-Jet 2V 	1½"	1½"	233	32	169	80		
169413	2" Barrel Silencer (Threaded in/out)	<ul style="list-style-type: none"> Medio-Jet Medio-Jet 2V Medio-Jet 350 Medio-Jet 1AC 	2"	2"	263	32	199	89		
169415	Uni-Jet 500 Silencer 2.5i"	<ul style="list-style-type: none"> Uni-Jet 500 Uni-Jet 501 	2½"	2½"	270	35	200	98		
169417	4" Barrel Silencer (Threaded in/out end)	<ul style="list-style-type: none"> Uni-Jet 1000 	4"	4"	480	37	406	152		
169382	Barrel Silencer (Threaded in/out end)	<ul style="list-style-type: none"> Uni-Jet 2200 	150	150	620	60	500	209		

TECHNICAL DATA			THREADED FLANGE KIT							
Item Code	Name	Product Suitability	A	B	C	D	E	F	G	H
169769	Threaded Flange Kit ¾"	<ul style="list-style-type: none"> Uni-Jet 40 	¾"	6.5	8	54	36	54	76	
169752	Threaded Flange Kit 1"	<ul style="list-style-type: none"> Uni-Jet 40 	1"	6.5	8	54	25	54	76	
169750	Threaded Flange Kit	<ul style="list-style-type: none"> Uni-Jet 75 Uni-Jet 75 2V 	1¼"	6.5	8	54	25	52	76	
169770	Threaded Flange Kit	<ul style="list-style-type: none"> Flux-Jet 	1½"	8.5	8	83	23	62	98	
169751	Threaded Flange Kit	<ul style="list-style-type: none"> Medio-Jet Medio-Jet 2V Medio-Jet 350 Medio-Jet 1AC 	2"	8.5	8	83	23	72	98	

TECHNICAL DATA			TUBEHOLDER FLANGE KIT							
Item Code	Name	Product Suitability	A	B	C	D	E	F	G	H
169766	Tubeholder Flange Kit D30	<ul style="list-style-type: none"> Uni-Jet 40 	36	30	25	5	Ø 6.5	54	27	76
169760	Tubeholder Flange Kit D30		36	30	25	5	Ø 6.5	64	27	76
169761	Tubeholder Flange Kit D38	<ul style="list-style-type: none"> Uni-Jet 75 	50	38	34	5	6	60	26	74
169762	Tubeholder Flange Kit D40	<ul style="list-style-type: none"> Uni-Jet 75 2V 	50	40	34	5	6	60	26	74
169771	Tubeholder Flange Kit D50		52.2	50	46	2.5	Ø 7	29x57	-	75
169773	Tubeholder Flange Kit D50	<ul style="list-style-type: none"> Tecno-Jet Tecno-Jet 2V 	48	50	43	8	Ø 6.5	72	32.5	98
169772	Tubeholder Flange Kit D50		70	50	48	8	Ø 8.5	83	36	98
169774	Tubeholder Flange Kit D50		48	50	43	8	Ø 8.5	83	32.5	98
169763	Tubeholder Flange Kit D50	<ul style="list-style-type: none"> Flux-Jet Flux-Jet 2V 	120	50	48	8	Ø 8.5	83	36	98
169764	Tubeholder Flange Kit D40		120	40	38	8	Ø 8.5	83	31	98
169767	Tubeholder Flange Kit D60		48	60	52	8	Ø 8	83	36	97
169767	Tubeholder Flange Kit D60	<ul style="list-style-type: none"> Medio-Jet Medio-Jet 2V 	48	60	52	8	Ø 8	83	36	97
169774	Tubeholder Flange Kit D50	<ul style="list-style-type: none"> Medio-Jet 350 Medio-Jet 1AC 	48	50	43	8	Ø 8.5	83	32.5	98
169776	Tubeholder Flange Kit D50	<ul style="list-style-type: none"> Uni-Jet 2200 	152.5	150	142	5	Ø 12	Ø 156	-	200

TECHNICAL DATA				INLET FILTER							
Item Code	Name	Product Suitability		A	B	C	D	E	F	G	H
168554	1" Mesh Inlet Filter	• Uni-Jet 40		1"	62	82	69				
168550	1¼" Mesh Inlet Filter	• Uni-Jet 75 • Uni-Jet 75 2V		1¼"	62	113	69				
168553	1½" Mesh Inlet Filter	• Tecno-Jet • Tecno-Jet 2V • Flux-Jet • Flux-Jet 2V • Uni-Jet 160		1½"	81	113	80				
168555	2" Mesh Inlet Filter	• Medio-Jet • Medio-Jet 2V • Medio-Jet 350		2"	134	164	89				

TECHNICAL DATA				VACUUM FILTER							
Item Code	Name	Product Suitability	Replacement Filter	A	B	C	D	E	F	G	H
168560	1¼" Complete Vacuum Filter	• Uni-Jet 75 • Tecno-Jet	167671	161	156	200	176	1¼"	1¼"		
168564	1½" Complete Vacuum Filter	• Tecno-Jet 2V • Uni-Jet 160	167673	200	185	200	176	1½"	1½"		
168564	1½" Complete Vacuum Filter	• Flux-Jet • Flux-Jet 2V	167673	200	185	200	176	1½"	1½"		
168561	2" Complete Vacuum Filter	• Medio-Jet • Medio-Jet 2V • Medio-Jet 350 • Medio-Jet 1AC	167672	258	211	226	200	2"	2"		
168543	2½" Complete Vacuum Filter	• Uni-Jet 501 • Uni-Jet 500	167672	258	211	226	200	2½"	2½"		
168544	4" Complete Vacuum Filter	• Uni-Jet 1000 • Uni-Jet 1500	167679	320	300	340	305	4"	4"		
168419	6" Complete Inlet Filter & Suction Filter	• Uni-Jet 2200	168444	670	560	720	600	160	160		

TECHNICAL DATA				CARTRIDGE SUCTION FILTER & REPLACEMENT FILTERS							
Item Code	Name	Product Suitability	Replacement Filter	A	B	C	D	E	F	G	H
168410	1" Complete Inlet Filter	• Uni-Jet 40	167690	140	40	130	1"				
168411	1¼" Complete Inlet Filter	• Uni-Jet 75 • Uni-Jet 75 2V	167690	140	40	130	1¼"				
168412	1½" Complete Inlet Filter	• Tecno-Jet • Tecno-Jet 2V • Flux-Jet • Flux-Jet 2V • Uni-Jet 160	167691	175	45	130	1½"				
168491	2" Complete Inlet Filter	• Medio-Jet • Medio-Jet 2V • Medio-Jet 350 • Medio-Jet 1AC	167692	210	50	172	2"				
168534	2½" Complete Inlet Filter	• Uni-Jet 501 • Uni-Jet 500	167670	220	60	195	2½"				
168537	4" Complete Inlet Filter	• Uni-Jet 1000 • Uni-Jet 1500	167678	300	603	20	4"				
168419	6" Complete Inlet Filter & Suction Filter	• Uni-Jet 2200	168444	670	560	720	600	160	160		

PRESSURE RELIEF VALVE

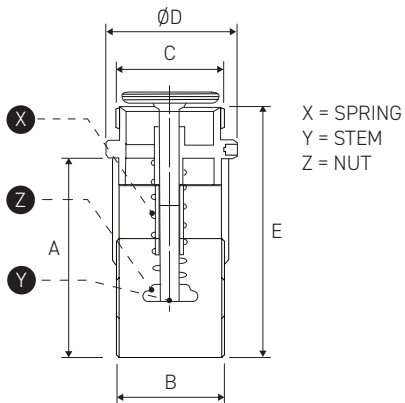

VACUUM RELIEF VALVE

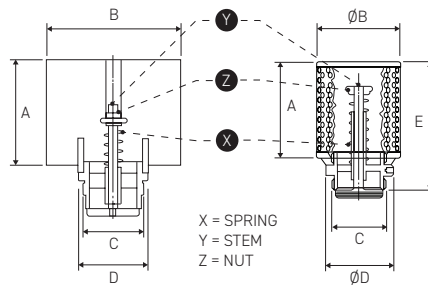

THREADED FLANGE KIT

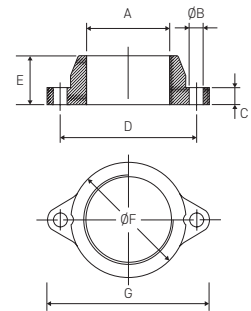

ONE ENDED SUPPLEMENTARY SILENCER

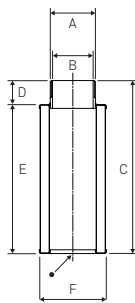

DOUBLE ENDED SUPPLEMENTARY SILENCER

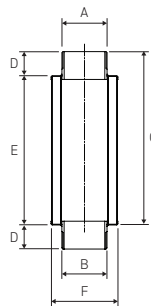

TUBEHOLDER FLANGE KIT

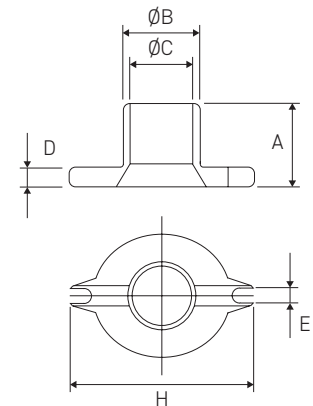

MESH INLET FILTER

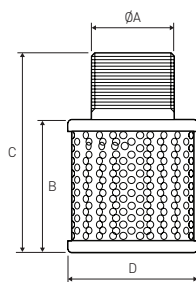

VACUUM FILTER

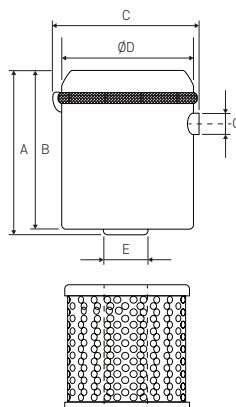

CARTRIDGE SUCTION FILTER & REPLACEMENT FILTERS

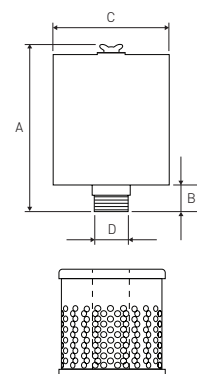

OIL-FREE COMPRESSORS

HYGIENIC AND DRY AIR

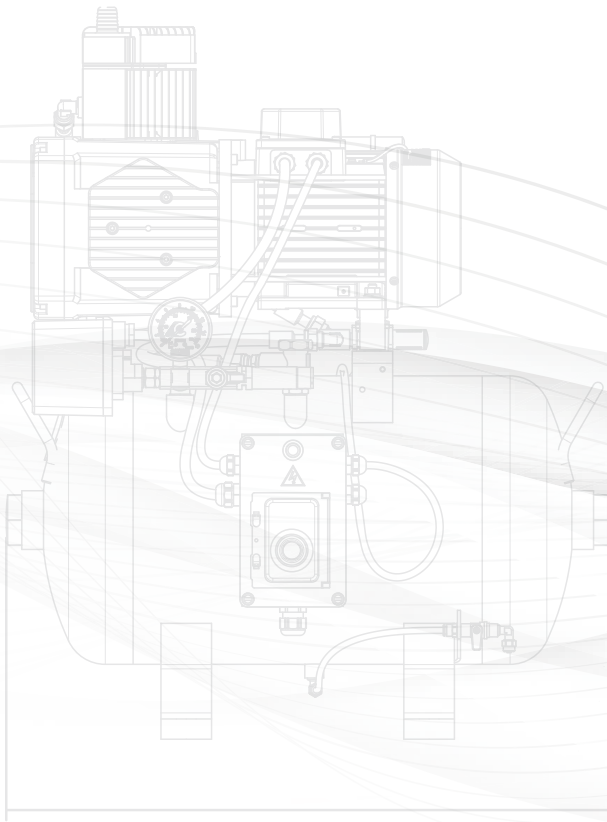

ESAM compressors blend precision with power, setting the standard in the industrial arena. Delivering hygienic, oil-free, dry air for critical applications from food processing to healthcare, they're crafted for relentless reliability and peak performance 24/7. As the foundation of operations, their robust build and advanced technology don't just complete tasks—they conquer them. With four decades of excellence, ESAM stands as a pivotal force in industrial innovation, securing wins across the globe.

In applications where hygienic, dry, oil-free compressed air is critical to the success of the operation, ESAM's specialist knowledge comes into its own. For more than 40 years the focus is to deliver the highest quality compressors through research and innovation. Our range of compressors utilise a multi-stage process of cleaning and drying the air. Refined over decades this system requires minimal maintenance ensuring ongoing servicing costs are kept to a minimum.

PURITY THROUGH 8-STAGE AIR TREATMENT

- 1 PARTICLE FILTER**
Helps protect the head unit by removing particles down to 20 microns.
- 2 CYCLONE TECHNOLOGY**
First stage of removing condensation and water from the air.
- 3 FINE PARTICLE FILTER**
Helps remove additional particles from the air prior to desiccant dryer.
- 4 DESICCANT DRYING SYSTEM**
Passive process to remove humidity from the air.
- 5 SINTERED BRONZE FILTER**
Pre-filter to help protect the HEPA H14 filter.
- 6 HEPA H14 FILTER**
Antibacterial filter removes 99.975% of all particles down to 0.3 micron.
- 7 FOOD GRADE COATING**
ESAM Compressor tanks are lined with a food grade resin coating.
- 8 ANTIBACTERIAL COATING**
A special coating uses silver ion technology for antibacterial protection.

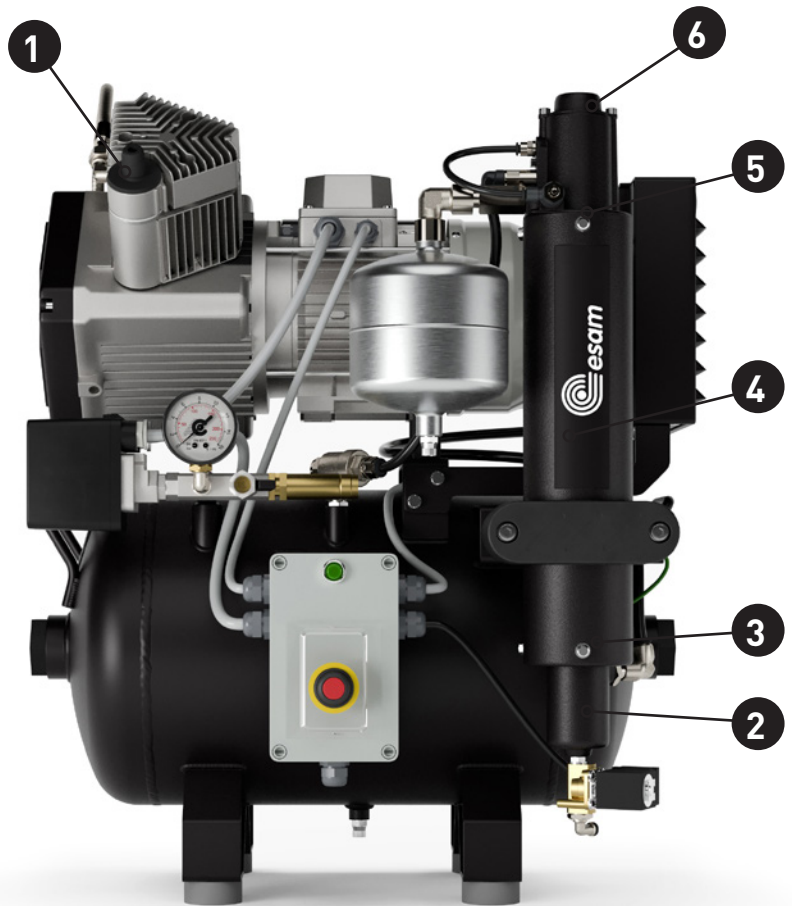

HEPA H14 FILTER AS STANDARD

Our antibacterial HEPA H14 filter comes standard with every desiccant dryer compressor.



ESAM100

OIL-FREE AIR COMPRESSOR

The ESAM100 single cylinder compressor provides oil-free operation through its unique design. Our compressors are rigorously tested to consistently deliver consistent clean, dry, and hygienic air through 8-stage air treatment. Best of all these compressors only require minimal annual maintenance.



DETAILS THAT MATTER

- » 5-years compressor warranty
- » Certified food grade resin coated tank
- » Anti-microbial silver-ion tank lining
- » Suitable for use with the Acoustic Cabinet (010800)
- » Motor protection switch to protect from overload



TECHNICAL DATA

ESAM100

Item Code	kW	Amp	Phases	Volt	Max. Air Flow at 5 Bar NU/min	Tank Size Litres	Cylinders	Sound dB(A)	Height	Width	Depth	Weight Kg
010130	0.55	3.8	1	230	67.5	30	1	70	720	620	460	47

ACCESSORIES

168429	HEPA H14 Compressor Drying Column Filter 1-Pack
168563	Air Inlet Filter for Compressor Head Unit
KSK1013B	Minor Service Kit - 1 Cylinder Head Unit and HEPA H14 Filter for Drying Column
KSK101B	Intermediate Service Kit - 1 Cylinder Head Unit, 1PH Capacitor and HEPA H14 Filter for Drying Column
DRK2000	Single Phase Parallel Connection Kit - Parallel connection of like-for-like compressor operation
010800	Acoustic Cabinet for AC100, AC200 and AC300 versions (W870 x H887 x D700 mm)

ESAM100E

OIL-FREE AIR COMPRESSOR WITH PRE-FILTER

The ESAM100E single cylinder compressor provides oil-free operation through its specialised design. The "E" models include a pre-filter on the drying column to remove excess moisture prior to entering system aiding in the deliver consistent clean, dry, and hygienic air. This is especially in areas where there is high-humidity.

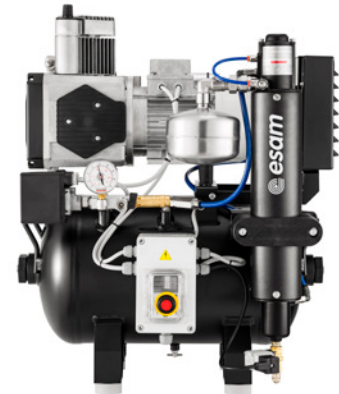

DETAILS THAT MATTER

- » 5-years compressor warranty
- » Certified food grade resin coated tank
- » Anti-microbial silver-ion tank lining
- » Suitable for use with the Acoustic Cabinet (010800)
- » Motor protection switch to protect from overload



TECHNICAL DATA

ESAM100E

Item Code	kW	Amp	Phases	Volt	Max. Air Flow at 5 Bar NL/min	Tank Size Litres	Cylinders	Sound dB(A)	Height	Width	Depth	Weight Kg
010130E	0.55	3.8	1	230	67.5	30	1	70	720	620	460	47.6

ACCESSORIES

168429	HEPA H14 Compressor Drying Column Filter 1-Pack
168563	Air Inlet Filter for Compressor Head Unit
KSK1013B	Minor Service Kit - 1 Cylinder Head Unit and HEPA H14 Filter for Drying Column
KSK101B	Intermediate Service Kit - 1 Cylinder Head Unit, 1PH Capacitor and HEPA H14 Filter for Drying Column
DRK2000	Single Phase Parallel Connection Kit - Parallel connection of like-for-like compressor operation
010800	Acoustic Cabinet for AC100, AC200 and AC300 versions (W870 x H887 x D700 mm)

ESAM200

OIL-FREE AIR COMPRESSOR

The ESAM200 dual-cylinder compressor provides oil-free operation through its unique design. Our compressors are rigorously tested to consistently deliver consistent clean, dry, and hygienic air through 8-stage air treatment. Best of all these compressors only require minimal annual maintenance.

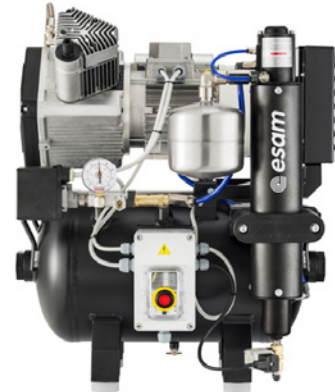

DETAILS THAT MATTER

- » 5-years compressor warranty
- » Certified food grade resin coated tank
- » Anti-microbial silver-ion tank lining
- » Suitable for use with the Acoustic Cabinet (010800)
- » Motor protection switch to protect from overload



TECHNICAL DATA

ESAM200

Item Code	kW	Amp	Phases	Volt	Max. Air Flow at 5 Bar NI/min	Tank Size Litres	Cylinders	Sound dB(A)	Height	Width	Depth	Weight Kg
010230	1.25	7.1	1	230	160	30	2	71	720	620	460	54

ACCESSORIES

168429	HEPA H14 Compressor Drying Column Filter 1-Pack
168563	Air Inlet Filter for Compressor Head Unit
KSK2013B	Minor Service Kit - 2 Cylinder Head Unit and HEPA H14 Filter for Drying Column
KSK201B	Intermediate Service Kit - 2 Cylinder Head Unit, 1PH Capacitor and HEPA H14 Filter for Drying Column
DRK2000	Single Phase Parallel Connection Kit - Parallel connection of like-for-like compressor operation
010800	Acoustic Cabinet for AC100, AC200 and AC300 versions (W870 x H887 x D700 mm)

ESAM200E

OIL-FREE AIR COMPRESSOR WITH PRE-FILTER

The ESAM200E dual-cylinder compressor provides oil-free operation through its specialised design. The "E" models include a pre-filter on the drying column to remove excess moisture prior to entering system aiding in the deliver consistent clean, dry, and hygienic air. This is especially in areas where there is high-humidity.



DETAILS THAT MATTER

- » 5-years compressor warranty
- » Certified food grade resin coated tank
- » Anti-microbial silver-ion tank lining
- » Suitable for use with the Acoustic Cabinet (010800)
- » Motor protection switch to protect from overload



TECHNICAL DATA

ESAM200E

Item Code	kW	Amp	Phases	Volt	Max. Air Flow at 5 Bar NI/min	Tank Size Litres	Cylinders	Sound dB(A)	Height	Width	Depth	Weight Kg
010230E	1.25	7.1	1	230	160	30	2	71	720	620	460	54.6

ACCESSORIES

168429	HEPA H14 Compressor Drying Column Filter 1-Pack
168563	Air Inlet Filter for Compressor Head Unit
KSK2013B	Minor Service Kit - 2 Cylinder Head Unit and HEPA H14 Filter for Drying Column
KSK201B	Intermediate Service Kit - 2 Cylinder Head Unit, 1PH Capacitor and HEPA H14 Filter for Drying Column
DRK2000	Single Phase Parallel Connection Kit - Parallel connection of like-for-like compressor operation
010800	Acoustic Cabinet for AC100, AC200 and AC300 versions (W870 x H887 x D700 mm)

ESAM300

OIL-FREE AIR COMPRESSOR

The ESAM300 triple-cylinder compressor provides oil-free operation through its unique design. Our compressors are rigorously tested to consistently deliver consistent clean, dry, and hygienic air through 8-stage air treatment. Best of all these compressors only require minimal annual maintenance.

DETAILS THAT MATTER

- » 5-years compressor warranty
- » Certified food grade resin coated tank
- » Anti-microbial silver-ion tank lining
- » Suitable for use with the Acoustic Cabinet (010800)
- » Motor protection switch to protect from overload



TECHNICAL DATA

ESAM300

Item Code	kW	Amp	Phases	Volt	Max. Air Flow at 5 Bar NL/min	Tank Size Litres	Cylinders	Sound dB(A)	Height	Width	Depth	Weight Kg
010330	1.5	9.2	1	230	238	45	3	73.6	750	620	520	65

ACCESSORIES

168429	HEPA H14 Compressor Drying Column Filter 1-Pack
168563	Air Inlet Filter for Compressor Head Unit
KSK3013B	Minor Service Kit - 3 Cylinder Head Unit and HEPA H14 Filter for Drying Column
KSK301B	Intermediate Service Kit - 3 Cylinder Head Unit, 1PH Capacitor and HEPA H14 Filter for Drying Column
DRK2000	Single Phase Parallel Connection Kit - Parallel connection of like-for-like compressor operation
010800	Acoustic Cabinet for AC100, AC200 and AC300 versions (W870 x H887 x D700 mm)

ESAM300E

OIL-FREE AIR COMPRESSOR WITH PRE-FILTER

The ESAM300E triple-cylinder compressor provides oil-free operation through its specialised design. The "E" models include a pre-filter on the drying column to remove excess moisture prior to entering system aiding in the deliver consistent clean, dry, and hygienic air. This is especially in areas where there is high-humidity.

DETAILS THAT MATTER

- » 5-years compressor warranty
- » Certified food grade resin coated tank
- » Anti-microbial silver-ion tank lining
- » Suitable for use with the Acoustic Cabinet (010800)
- » Motor protection switch to protect from overload

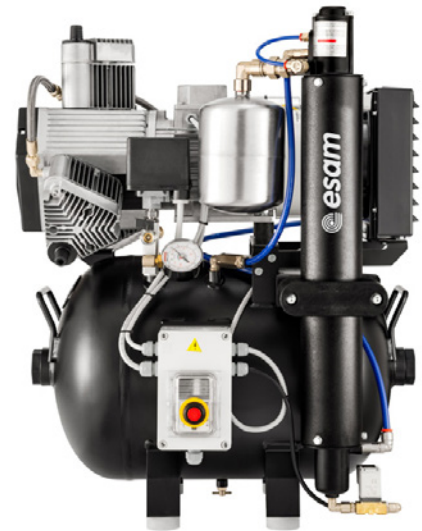

TECHNICAL DATA

ESAM300E

Item Code	kW	Amp	Phases	Volt	Max. Air Flow at 5 Bar NI/min	Tank Size Litres	Cylinders	Sound dB(A)	Height	Width	Depth	Weight Kg
010330E	1.5	9.2	1	230	238	45	3	73.6	750	620	520	65.6

ACCESSORIES

168429	HEPA H14 Compressor Drying Column Filter 1-Pack
168563	Air Inlet Filter for Compressor Head Unit
KSK3013B	Minor Service Kit - 3 Cylinder Head Unit and HEPA H14 Filter for Drying Column
KSK301B	Intermediate Service Kit - 3 Cylinder Head Unit, 1PH Capacitor and HEPA H14 Filter for Drying Column
DRK2000	Single Phase Parallel Connection Kit - Parallel connection of like-for-like compressor operation
010800	Acoustic Cabinet for AC100, AC200 and AC300 versions (W870 x H887 x D700 mm)

ESAM4001P

OIL-FREE AIR COMPRESSOR

The ESAM4001P double two-cylinder compressor provides oil-free operation through its unique design. Our compressors are rigorously tested to consistently deliver consistent clean, dry, and hygienic air through 8-stage air treatment. Best of all these compressors only require minimal annual maintenance.



DETAILS THAT MATTER

- » 5-years compressor warranty
- » Certified food grade resin coated tank
- » Anti-microbial silver-ion tank lining
- » Single Phase electrical connection
- » Motor protection switch to protect from overload



TECHNICAL DATA

ESAM4001P

Item Code	kW	Amp	Phases	Volt	Max. Air Flow at 5 Bar NI/min	Tank Size Litres	Cylinders	Sound dB(A)	Height	Width	Depth	Weight Kg
010430	2.4	15.4	1	230	320	100	Tandem 2	73	745	1200	5650	112

ACCESSORIES

- 168429 HEPA H14 Compressor Drying Column Filter 1-Pack
 - 168563 Air Inlet Filter for Compressor Head Unit
 - KSK2013B Minor Service Kit - 2 Cylinder Head Unit and HEPA H14 Filter for Drying Column
 - KSK201B Intermediate Service Kit - 1 Cylinder Head Unit, 1PH Capacitor and HEPA H14 Filter for Drying Column
- Please refer to service schedule for suitable quantity of service kits per compressor.

ESAM4001PE

OIL-FREE AIR COMPRESSOR

The ESAM4001PE double two-cylinder compressor provides oil-free operation through its specialised design. The “E” models include a pre-filter on the drying column to remove excess moisture prior to entering system aiding in the deliver consistent clean, dry, and hygienic air. This is especially in areas where there is high-humidity.



DETAILS THAT MATTER

- » 5-years compressor warranty
- » Certified food grade resin coated tank
- » Anti-microbial silver-ion tank lining
- » Single Phase electrical connection
- » Motor protection switch to protect from overload



TECHNICAL DATA

ESAM4001PE

Item Code	kW	Amp	Phases	Volt	Max. Air Flow at 5 Bar NI/min	Tank Size Litres	Cylinders	Sound dB(A)	Height	Width	Depth	Weight Kg
010430E	2.4	15.4	1	230	320	100	Tandem 2	73	745	1200	5650	113.2

ACCESSORIES

- 168429 HEPA H14 Compressor Drying Column Filter 1-Pack
 - 168563 Air Inlet Filter for Compressor Head Unit
 - KSK2013B Minor Service Kit - 2 Cylinder Head Unit and HEPA H14 Filter for Drying Column
 - KSK201B Intermediate Service Kit - 2 Cylinder Head Unit, 1PH Capacitor and HEPA H14 Filter for Drying Column
- Please refer to service schedule for suitable quantity of service kits per compressor.

ESAM400

OIL-FREE AIR COMPRESSOR

The ESAM400 double two-cylinder compressor provides oil-free operation through its unique design. Our compressors are rigorously tested to consistently deliver consistent clean, dry, and hygienic air through 8-stage air treatment. Best of all these compressors only require minimal annual maintenance.



DETAILS THAT MATTER

- » 5-years compressor warranty
- » Certified food grade resin coated tank
- » Anti-microbial silver-ion tank lining
- » Three Phase electrical connection
- » Motor protection switch to protect from overload



TECHNICAL DATA

ESAM400

Item Code	kW	Amp	Phases	Volt	Max. Air Flow at 5 Bar NI/min	Tank Size Litres	Cylinders	Sound dB(A)	Height	Width	Depth	Weight Kg
010435	3	7.2	3	400	320	100	Tandem 2	73	745	1200	550	112

ACCESSORIES

- 168429 HEPA H14 Compressor Drying Column Filter 1-Pack
- 168563 Air Inlet Filter for Compressor Head Unit
- KSK2013B Minor Service Kit - 2 Cylinder Head Unit and HEPA H14 Filter for Drying Column
Please refer to service schedule for suitable quantity of service kits per compressor.
- 070904 Three Phase Parallel Connection Kit - Parallel connection of like-for-like compressor operation

ESAM400E

OIL-FREE AIR COMPRESSOR

The ESAM400E double two-cylinder compressor provides oil-free operation through its specialised design. The “E” models include a pre-filter on the drying column to remove excess moisture prior to entering system aiding in the deliver consistent clean, dry, and hygienic air. This is especially in areas where there is high-humidity.



DETAILS THAT MATTER

- » 5-years compressor warranty
- » Certified food grade resin coated tank
- » Anti-microbial silver-ion tank lining
- » Three Phase electrical connection
- » Motor protection switch to protect from overload



TECHNICAL DATA

ESAM400E

Item Code	kW	Amp	Phases	Volt	Max. Air Flow at 5 Bar NI/min	Tank Size Litres	Cylinders	Sound dB(A)	Height	Width	Depth	Weight Kg
010435E	3	7.2	3	400	320	100	Tandem 2	73	745	1200	550	113.2

ACCESSORIES

168429	HEPA H14 Compressor Drying Column Filter 1-Pack
168563	Air Inlet Filter for Compressor Head Unit
KSK2013B	Minor Service Kit - 2 Cylinder Head Unit and HEPA H14 Filter for Drying Column
Please refer to service schedule for suitable quantity of service kits per compressor.	
070904	Three Phase Parallel Connection Kit - Parallel connection of like-for-like compressor operation

ESAM600

OIL-FREE AIR COMPRESSOR

The ESAM600 double two-cylinder compressor provides oil-free operation through its unique design. Our compressors are rigorously tested to consistently deliver consistent clean, dry, and hygienic air through 8-stage air treatment. Best of all these compressors only require minimal annual maintenance.



DETAILS THAT MATTER

- » 5-years compressor warranty
- » Certified food grade resin coated tank
- » Anti-microbial silver-ion tank lining
- » Motor protection switch to protect from overload



TECHNICAL DATA

ESAM600

Item Code	kW	Amp	Phases	Volt	Max. Air Flow at 5 Bar NI/min	Tank Size Litres	Cylinders	Sound dB(A)	Height	Width	Depth	Weight Kg
010535	3	7.4	3	400	476	150	Tandem 3	74	890	1320	590	124

ACCESSORIES

- 168429 HEPA H14 Compressor Drying Column Filter 1-Pack
- 168563 Air Inlet Filter for Compressor Head Unit
- KSK3013B Minor Service Kit - 3 Cylinder Head Unit and HEPA H14 Filter for Drying Column
Please refer to service schedule for suitable quantity of service kits per compressor.
- 070904 Three Phase Parallel Connection Kit - Parallel connection of like-for-like compressor operation

ESAM600E

OIL-FREE AIR COMPRESSOR

The ESAM600E double three-cylinder compressor provides oil-free operation through its specialised design. The “E” models include a pre-filter on the drying column to remove excess moisture prior to entering system aiding in the deliver consistent clean, dry, and hygienic air. This is especially in areas where there is high-humidity.



DETAILS THAT MATTER

- » 5-years compressor warranty
- » Certified food grade resin coated tank
- » Anti-microbial silver-ion tank lining
- » Motor protection switch to protect from overload



TECHNICAL DATA

ESAM600E

Item Code	kW	Amp	Phases	Volt	Max. Air Flow at 5 Bar NI/min	Tank Size Litres	Cylinders	Sound dB(A)	Height	Width	Depth	Weight Kg
010535E	3	7.4	3	400	476	150	Tandem 3	74	890	1320	590	125.2

ACCESSORIES

168429	HEPA H14 Compressor Drying Column Filter 1-Pack
168563	Air Inlet Filter for Compressor Head Unit
KSK3013B	Minor Service Kit - 3 Cylinder Head Unit and HEPA H14 Filter for Drying Column
Please refer to service schedule for suitable quantity of service kits per compressor.	
070904	Three Phase Parallel Connection Kit - Parallel connection of like-for-like compressor operation

ESAM900

OIL-FREE AIR COMPRESSOR

The ESAM900 triple three-cylinder compressor provides oil-free operation through its unique design. Our compressors are rigorously tested to consistently deliver consistent clean, dry, and hygienic air through 8-stage air treatment. Best of all these compressors only require minimal annual maintenance.



DETAILS THAT MATTER

- » 5-years compressor warranty
- » Certified food grade resin coated tank
- » Anti-microbial silver-ion tank lining
- » Motor protection switch to protect from overload



TECHNICAL DATA

ESAM900

Item Code	kW	Amp	Phases	Volt	Max. Air Flow at 5 Bar NI/min	Tank Size Litres	Cylinders	Sound dB(A)	Height	Width	Depth	Weight Kg
010599	4.5	11.1	3	400	714	300	Triple 3	75	1000	1800	810	260

ACCESSORIES

- 168429 HEPA H14 Compressor Drying Column Filter 1-Pack
- 168563 Air Inlet Filter for Compressor Head Unit
- KSK3013B Minor Service Kit - 3 Cylinder Head Unit and HEPA H14 Filter for Drying Column
Please refer to service schedule for suitable quantity of service kits per compressor.
- 070904 Three Phase Parallel Connection Kit - Parallel connection of like-for-like compressor operation

ESAM900E

OIL-FREE AIR COMPRESSOR

The ESAM900E double three-cylinder compressor provides oil-free operation through its specialised design. The “E” models include a pre-filter on the drying column to remove excess moisture prior to entering system aiding in the deliver consistent clean, dry, and hygienic air. This is especially in areas where there is high-humidity.



DETAILS THAT MATTER

- » 5-years compressor warranty
- » Certified food grade resin coated tank
- » Anti-microbial silver-ion tank lining
- » Motor protection switch to protect from overload



TECHNICAL DATA

ESAM900E

Item Code	kW	Amp	Phases	Volt	Max. Air Flow at 5 Bar NI/min	Tank Size Litres	Cylinders	Sound dB(A)	Height	Width	Depth	Weight Kg
010599E	4.5	11.1	3	400	714	300	Triple 3	75	1000	1800	810	261.8

ACCESSORIES

- 168429 HEPA H14 Compressor Drying Column Filter 1-Pack
- 168563 Air Inlet Filter for Compressor Head Unit
- KSK3013B Minor Service Kit - 3 Cylinder Head Unit and HEPA H14 Filter for Drying Column
Please refer to service schedule for suitable quantity of service kits per compressor.
- 070904 Three Phase Parallel Connection Kit - Parallel connection of like-for-like compressor operation

ESAM1200

OIL-FREE AIR COMPRESSOR

The ESAM1200 double six-cylinder compressor provides oil-free operation through its unique design. Our compressors are rigorously tested to consistently deliver consistent clean, dry, and hygienic air through 8-stage air treatment. Best of all these compressors only require minimal annual maintenance.



DETAILS THAT MATTER

- » 5-years compressor warranty
- » Certified food grade resin coated tank
- » Anti-microbial silver-ion tank lining
- » Motor protection switch to protect from overload



TECHNICAL DATA

ESAM1200

Item Code	kW	Amp	Phases	Volt	Max. Air Flow at 5 Bar NI/min	Tank Size Litres	Cylinders	Sound dB(A)	Height	Width	Depth	Weight Kg
013595	6.5	15	3	400	952	300	Tandem 6	81	1100	1800	880	303

ACCESSORIES

168429	HEPA H14 Compressor Drying Column Filter 1-Pack
168563	Air Inlet Filter for Compressor Head Unit
KSK010611B	Minor Service Kit - 6 Cylinder Head Unit and HEPA H14 Filter for Drying Column Please refer to service schedule for suitable quantity of service kits per compressor.
070904	Three Phase Parallel Connection Kit - Parallel connection of like-for-like compressor operation

ESAM1200E

OIL-FREE AIR COMPRESSOR

The ESAM1200E double six-cylinder compressor provides oil-free operation through its specialised design. The “E” models include a pre-filter on the drying column to remove excess moisture prior to entering system aiding in the deliver consistent clean, dry, and hygienic air. This is especially in areas where there is high-humidity.



DETAILS THAT MATTER

- » 5-years compressor warranty
- » Certified food grade resin coated tank
- » Anti-microbial silver-ion tank lining
- » Motor protection switch to protect from overload



TECHNICAL DATA

ESAM1200E

Item Code	kW	Amp	Phases	Volt	Max. Air Flow at 5 Bar NI/min	Tank Size Litres	Cylinders	Sound dB(A)	Height	Width	Depth	Weight Kg
010595E	6.5	15	3	400	952	300	Tandem 6	81	1100	1800	880	305.4

ACCESSORIES

168429	HEPA H14 Compressor Drying Column Filter 1-Pack
168563	Air Inlet Filter for Compressor Head Unit
KSK010611B	Minor Service Kit - 6 Cylinder Head Unit and HEPA H14 Filter for Drying Column Please refer to service schedule for suitable quantity of service kits per compressor.
070904	Three Phase Parallel Connection Kit - Parallel connection of like-for-like compressor operation

ESAM1800

OIL-FREE AIR COMPRESSOR

The ESAM1800 double six-cylinder compressor provides oil-free operation through its unique design. Our compressors are rigorously tested to consistently deliver consistent clean, dry, and hygienic air through 8-stage air treatment. Best of all these compressors only require minimal annual maintenance.



DETAILS THAT MATTER

- » 5-years compressor warranty
- » Certified food grade resin coated tank
- » Anti-microbial silver-ion tank lining
- » Motor protection switch to protect from overload



TECHNICAL DATA

ESAM1800

Item Code	kW	Amp	Phases	Volt	Max. Air Flow at 5 Bar NI/min	Tank Size Litres	Cylinders	Sound dB(A)	Height	Width	Depth	Weight Kg
010594	9.75	22.6	3	400	1428	300	Triple 6	82.5	1100	1800	1100	394

AIR COMPRESSORS

ACCESSORIES

168429	HEPA H14 Compressor Drying Column Filter 1-Pack
168563	Air Inlet Filter for Compressor Head Unit
KSK010611B	Minor Service Kit - 6 Cylinder Head Unit and HEPA H14 Filter for Drying Column Please refer to service schedule for suitable quantity of service kits per compressor.
070904	Three Phase Parallel Connection Kit - Parallel connection of like-for-like compressor operation

ESAM1800E

OIL-FREE AIR COMPRESSOR

The ESAM1800E triple six-cylinder compressor provides oil-free operation through its specialised design. The “E” models include a pre-filter on the drying column to remove excess moisture prior to entering system aiding in the deliver consistent clean, dry, and hygienic air. This is especially in areas where there is high-humidity.



DETAILS THAT MATTER

- » 5-years compressor warranty
- » Certified food grade resin coated tank
- » Anti-microbial silver-ion tank lining
- » Motor protection switch to protect from overload



TECHNICAL DATA

ESAM1800E

Item Code	kW	Amp	Phases	Volt	Max. Air Flow at 5 Bar NI/min	Tank Size Litres	Cylinders	Sound dB(A)	Height	Width	Depth	Weight Kg
010594E	9.75	22.6	3	400	1428	300	Triple 6	82.5	1100	1800	1100	397.6

ACCESSORIES

168429	HEPA H14 Compressor Drying Column Filter 1-Pack
168563	Air Inlet Filter for Compressor Head Unit
KSK010611B	Minor Service Kit - 6 Cylinder Head Unit and HEPA H14 Filter for Drying Column Please refer to service schedule for suitable quantity of service kits per compressor.
070904	Three Phase Parallel Connection Kit - Parallel connection of like-for-like compressor operation

QUIET 5-BAR COMPRESSORS

HYGIENIC AND DRY AIR

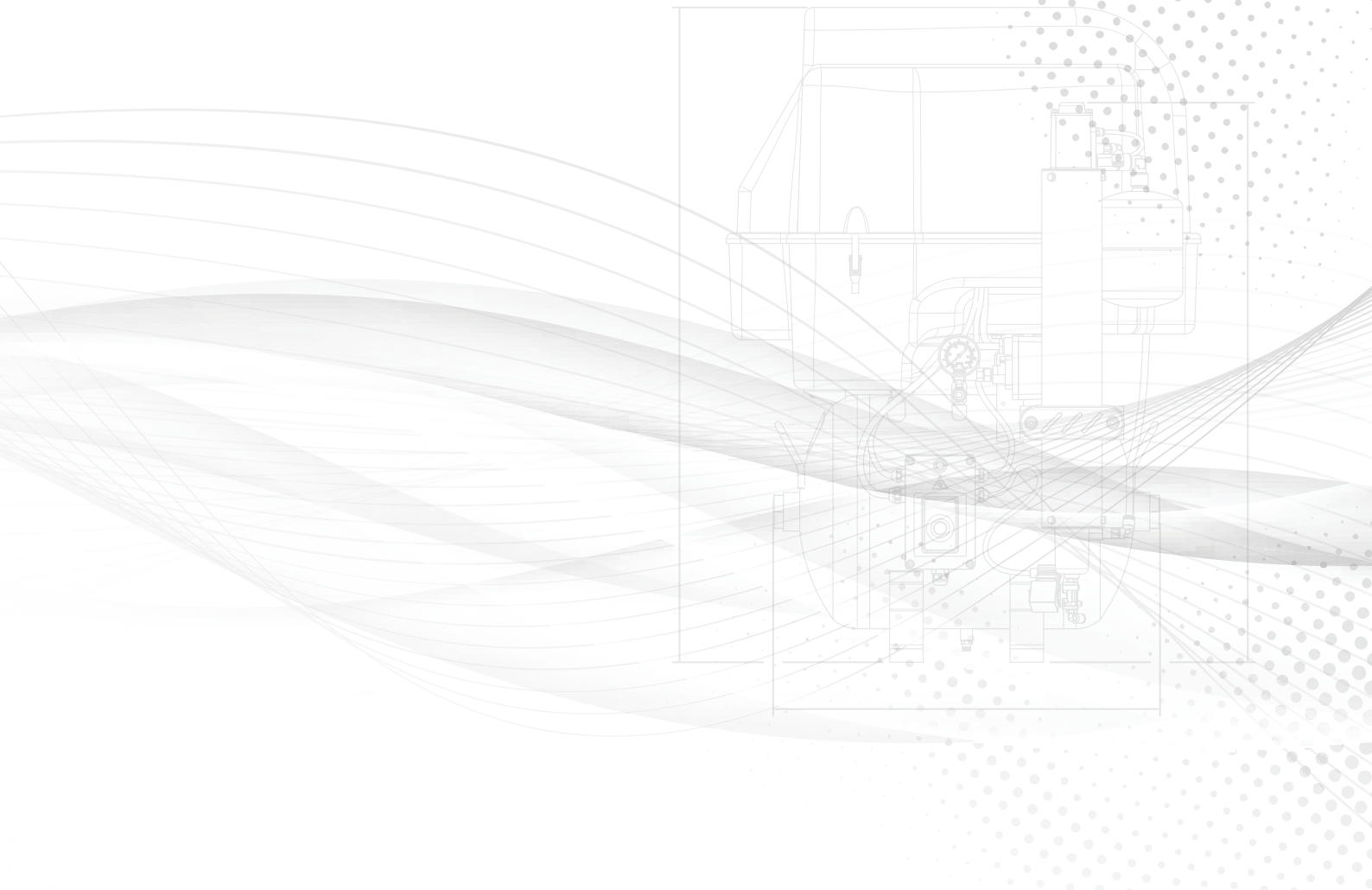

ESAM's Quiet 5-Bar Compressors blend subtlety with performance, delivering hygienic, oil-free, dry air, ideal for sensitive environments that require reliability and precision. With a legacy of innovation, ESAM compressors offer a low-noise operating solution without compromising performance, embodying four decades of ESAM's commitment to excellence and specialised air technology.

ESAM100Q

QUIET OIL-FREE AIR COMPRESSOR

The ESAM100Q, quiet series single cylinder compressor provides oil-free and quiet operation through its unique design. Our compressors are rigorously tested to consistently deliver consistent clean, dry, and hygienic air through 8-stage air treatment. Best of all these compressors only require minimal annual maintenance.

DETAILS THAT MATTER

- » Low-noise operation at 63dB(A)
- » 5-years compressor warranty
- » Certified food grade resin coated tank
- » Anti-microbial silver-ion tank lining
- » Motor protection switch to protect from overload



TECHNICAL DATA

ESAM100Q

Item Code	kW	Amp	Phases	Volt	Max. Air Flow at 5 Bar NI/min	Tank Size Litres	Cylinders	Sound dB(A)	Height	Width	Depth	Weight Kg
013144	0.55	3.8	1	230	67.5	30	1	63	860	660	600	57

ACCESSORIES

168429	HEPA H14 Compressor Drying Column Filter 1-Pack
168563	Air Inlet Filter for Compressor Head Unit
KSK1013B	Minor Service Kit - 1 Cylinder Head Unit and HEPA H14 Filter for Drying Column
KSK101B	Intermediate Service Kit - 1 Cylinder Head Unit, 1PH Capacitor and HEPA H14 Filter for Drying Column
DRK2000	Single Phase Parallel Connection Kit - Parallel connection of like-for-like compressor operation
010800	Acoustic Cabinet for AC100, AC200 and AC300 versions (W870 x H887 x D700 mm)

ESAM100QE

QUIET OIL-FREE AIR COMPRESSOR

The ESAM100QE, quiet series single cylinder compressor provides oil-free and quiet operation through its unique design. The "E" models include a pre-filter on the drying column to remove excess moisture prior to entering system aiding in the deliver consistent clean, dry, and hygienic air. This is especially in areas where there is high-humidity.



DETAILS THAT MATTER

- » Low-noise operation at 63dB(A)
- » 5-years compressor warranty
- » Certified food grade resin coated tank
- » Anti-microbial silver-ion tank lining
- » Motor protection switch to protect from overload



TECHNICAL DATA

ESAM100QE

Item Code	kW	Amp	Phases	Volt	Max. Air Flow at 5 Bar NI/min	Tank Size Litres	Cylinders	Sound dB(A)	Height	Width	Depth	Weight Kg
013144E	0.55	3.8	1	230	67.5	30	1	63	860	660	600	57.6

ACCESSORIES

168429	HEPA H14 Compressor Drying Column Filter 1-Pack
168563	Air Inlet Filter for Compressor Head Unit
KSK1013B	Minor Service Kit - 1 Cylinder Head Unit and HEPA H14 Filter for Drying Column
KSK101B	Intermediate Service Kit - 1 Cylinder Head Unit, 1PH Capacitor and HEPA H14 Filter for Drying Column
DRK2000	Single Phase Parallel Connection Kit - Parallel connection of like-for-like compressor operation
010800	Acoustic Cabinet for AC100, AC200 and AC300 versions (W870 x H887 x D700 mm)

ESAM200Q

QUIET OIL-FREE AIR COMPRESSOR

The ESAM200Q, quiet series dual cylinder compressor provides oil-free and quiet operation through its unique design. Our compressors are rigorously tested to consistently deliver consistent clean, dry, and hygienic air through 8-stage air treatment. Best of all these compressors only require minimal annual maintenance.

DETAILS THAT MATTER

- » Low-noise operation at 63dB(A)
- » 5-years compressor warranty
- » Certified food grade resin coated tank
- » Anti-microbial silver-ion tank lining
- » Motor protection switch to protect from overload



TECHNICAL DATA

ESAM200Q

Item Code	kW	Amp	Phases	Volt	Max. Air Flow at 5 Bar NI/min	Tank Size Litres	Cylinders	Sound dB(A)	Height	Width	Depth	Weight Kg
013244	1.25	7.1	1	230	160	30	2	63	860	660	600	64

ACCESSORIES

168429	HEPA H14 Compressor Drying Column Filter 1-Pack
168563	Air Inlet Filter for Compressor Head Unit
KSK2013B	Minor Service Kit - 2 Cylinder Head Unit and HEPA H14 Filter for Drying Column
KSK201B	Intermediate Service Kit - 2 Cylinder Head Unit, 1PH Capacitor and HEPA H14 Filter for Drying Column
DRK2000	Single Phase Parallel Connection Kit - Parallel connection of like-for-like compressor operation

ESAM200QE

QUIET OIL-FREE AIR COMPRESSOR

The ESAM200QE, quiet series dual cylinder compressor provides oil-free and quiet operation through its unique design. The "E" models include a pre-filter on the drying column to remove excess moisture prior to entering system aiding in the deliver consistent clean, dry, and hygienic air. This is especially in areas where there is high-humidity.



DETAILS THAT MATTER

- » Low-noise operation at 63dB(A)
- » 5-years compressor warranty
- » Certified food grade resin coated tank
- » Anti-microbial silver-ion tank lining
- » Motor protection switch to protect from overload



TECHNICAL DATA

ESAM200QE

Item Code	kW	Amp	Phases	Volt	Max. Air Flow at 5 Bar NI/min	Tank Size Litres	Cylinders	Sound dB(A)	Height	Width	Depth	Weight Kg
013244E	1.25	7.1	1	230	160	30	2	63	860	660	600	64.6

ACCESSORIES

- 168429 HEPA H14 Compressor Drying Column Filter 1-Pack
- 168563 Air Inlet Filter for Compressor Head Unit
- KSK2013B Minor Service Kit - 2 Cylinder Head Unit and HEPA H14 Filter for Drying Column
- KSK201B Intermediate Service Kit - 2 Cylinder Head Unit, 1PH Capacitor and HEPA H14 Filter for Drying Column
- DRK2000 Single Phase Parallel Connection Kit - Parallel connection of like-for-like compressor operation

ESAM300Q

QUIET OIL-FREE AIR COMPRESSOR

The ESAM300Q, quiet series triple cylinder compressor provides oil-free operation and quiet through its unique design. Our compressors are rigorously tested to consistently deliver consistent clean, dry, and hygienic air through 8-stage air treatment. Best of all these compressors only require minimal annual maintenance.

DETAILS THAT MATTER

- » Low-noise operation at 68dB(A)
- » 5-years compressor warranty
- » Certified food grade resin coated tank
- » Anti-microbial silver-ion tank lining
- » Motor protection switch to protect from overload



TECHNICAL DATA

ESAM300Q

Item Code	kW	Amp	Phases	Volt	Max. Air Flow at 5 Bar NI/min	Tank Size Litres	Cylinders	Sound dB(A)	Height	Width	Depth	Weight Kg
013344	1.5	10.2	1	230	238	45	3	68	979	720	700	80

ACCESSORIES

168429	HEPA H14 Compressor Drying Column Filter 1-Pack
168563	Air Inlet Filter for Compressor Head Unit
KSK3013B	Minor Service Kit - 3 Cylinder Head Unit and HEPA H14 Filter for Drying Column
KSK301B	Intermediate Service Kit - 3 Cylinder Head Unit, 1PH Capacitor and HEPA H14 Filter for Drying Column
DRK2000	Single Phase Parallel Connection Kit - Parallel connection of like-for-like compressor operation

ESAM300QE

QUIET OIL-FREE AIR COMPRESSOR

The ESAM300QE, quiet series triple cylinder compressor provides oil-free and quiet operation through its unique design. The "E" models include a pre-filter on the drying column to remove excess moisture prior to entering system aiding in the deliver consistent clean, dry, and hygienic air. This is especially in areas where there is high-humidity.



DETAILS THAT MATTER

- » Low-noise operation at 68dB(A)
- » 5-years compressor warranty
- » Certified food grade resin coated tank
- » Anti-microbial silver-ion tank lining
- » Motor protection switch to protect from overload



TECHNICAL DATA

ESAM300QE

Item Code	kW	Amp	Phases	Volt	Max. Air Flow at 5 Bar NI/min	Tank Size Litres	Cylinders	Sound dB(A)	Height	Width	Depth	Weight Kg
013344E	1.5	10.2	1	230	238	45	3	68	979	720	700	80.6

ACCESSORIES

- 168429 HEPA H14 Compressor Drying Column Filter 1-Pack
- 168563 Air Inlet Filter for Compressor Head Unit
- KSK3013B Minor Service Kit - 3 Cylinder Head Unit and HEPA H14 Filter for Drying Column
- KSK301B Intermediate Service Kit - 3 Cylinder Head Unit, 1PH Capacitor and HEPA H14 Filter for Drying Column
- DRK2000 Single Phase Parallel Connection Kit - Parallel connection of like-for-like compressor operation

ESAM400Q1P

QUIET OIL-FREE AIR COMPRESSOR

The ESAM400Q1P, quiet series tandem two cylinder compressor provides oil-free and quiet operation through its unique design. Our compressors are rigorously tested to consistently deliver consistent clean, dry, and hygienic air through 8-stage air treatment. Best of all these compressors only require minimal annual maintenance.



DETAILS THAT MATTER

- » Low-noise operation at 63.8dB(A)
- » 5-years compressor warranty
- » Certified food grade resin coated tank
- » Anti-microbial silver-ion tank lining
- » Single Phase electrical connection
- » Motor protection switch to protect from overload



TECHNICAL DATA

ESAM400Q1P

Item Code	kW	Amp	Phases	Volt	Max. Air Flow at 5 Bar NI/min	Tank Size Litres	Cylinders	Sound dB(A)	Height	Width	Depth	Weight Kg
013444	2.4	15.4	1	230	320	100	Tandem 2	63.8	890	1200	550	135

ACCESSORIES

168429	HEPA H14 Compressor Drying Column Filter 1-Pack
168563	Air Inlet Filter for Compressor Head Unit
KSK2013B	Minor Service Kit - 2 Cylinder Head Unit and HEPA H14 Filter for Drying Column
KSK201B	Intermediate Service Kit - 2 Cylinder Head Unit, 1PH Capacitor and HEPA H14 Filter for Drying Column
DRK2000	Single Phase Parallel Connection Kit - Parallel connection of like-for-like compressor operation

ESAM400Q1PE

QUIET OIL-FREE AIR COMPRESSOR

The ESAM400Q1PE, quiet series tandem two cylinder compressor provides oil-free and quiet operation through its unique design. The “E” models include a pre-filter on the drying column to remove excess moisture prior to entering system aiding in the deliver consistent clean, dry, and hygienic air. This is especially in areas where there is high-humidity.



DETAILS THAT MATTER

- » Low-noise operation at 63.8dB(A)
- » 5-years compressor warranty
- » Certified food grade resin coated tank
- » Anti-microbial silver-ion tank lining
- » Single Phase electrical connection
- » Motor protection switch to protect from overload



TECHNICAL DATA

ESAM400Q1PE

Item Code	kW	Amp	Phases	Volt	Max. Air Flow at 5 Bar NL/min	Tank Size Litres	Cylinders	Sound dB(A)	Height	Width	Depth	Weight Kg
013444E	2.4	15.4	1	230	320	100	Tandem 2	63.8	890	1200	550	136.2

ACCESSORIES

168429	HEPA H14 Compressor Drying Column Filter 1-Pack
168563	Air Inlet Filter for Compressor Head Unit
KSK2013B	Minor Service Kit - 2 Cylinder Head Unit and HEPA H14 Filter for Drying Column
KSK201B	Intermediate Service Kit -2 Cylinder Head Unit, 1PH Capacitor and HEPA H14 Filter for Drying Column
DRK2000	Single Phase Parallel Connection Kit - Parallel connection of like-for-like compressor operation

ESAM400Q

QUIET OIL-FREE AIR COMPRESSOR

The ESAM400Q, quiet series tandem two cylinder compressor provides oil-free and quiet operation through its unique design. Our compressors are rigorously tested to consistently deliver consistent clean, dry, and hygienic air through 8-stage air treatment. Best of all these compressors only require minimal annual maintenance.



DETAILS THAT MATTER

- » Low-noise operation at 63.8dB(A)
- » 5-years compressor warranty
- » Certified food grade resin coated tank
- » Anti-microbial silver-ion tank lining
- » Three Phase electrical connection
- » Motor protection switch to protect from overload



TECHNICAL DATA

ESAM400Q

Item Code	kW	Amp	Phases	Volt	Max. Air Flow at 5 Bar NI/min	Tank Size Litres	Cylinders	Sound dB(A)	Height	Width	Depth	Weight Kg
013450	3	7.4	3	400	320	100	Tandem 2	63.8	890	1200	650	135

ACCESSORIES

- 168429 HEPA H14 Compressor Drying Column Filter 1-Pack
- 168563 Air Inlet Filter for Compressor Head Unit
- KSK2013B Minor Service Kit - 2 Cylinder Head Unit and HEPA H14 Filter for Drying Column
Please refer to service schedule for suitable quantity of service kits per compressor.
- 070904 Three Phase Parallel Connection Kit - Parallel connection of like-for-like compressor operation

ESAM400QE

QUIET OIL-FREE AIR COMPRESSOR

The ESAM400QE, quiet series tandem two cylinder compressor provides oil-free and quiet operation through its unique design. The “E” models include a pre-filter on the drying column to remove excess moisture prior to entering system aiding in the deliver consistent clean, dry, and hygienic air. This is especially in areas where there is high-humidity.



DETAILS THAT MATTER

- » Low-noise operation at 63.8dB(A)
- » 5-years compressor warranty
- » Certified food grade resin coated tank
- » Anti-microbial silver-ion tank lining
- » Three Phase electrical connection
- » Motor protection switch to protect from overload



TECHNICAL DATA

ESAM400QE

Item Code	kW	Amp	Phases	Volt	Max. Air Flow at 5 Bar NI/min	Tank Size Litres	Cylinders	Sound dB(A)	Height	Width	Depth	Weight Kg
013450E	3	7.4	3	400	320	100	Tandem 2	63.8	890	1200	650	136.2

ACCESSORIES

- 168429 HEPA H14 Compressor Drying Column Filter 1-Pack
- 168563 Air Inlet Filter for Compressor Head Unit
- KSK2013B Minor Service Kit - 2 Cylinder Head Unit and HEPA H14 Filter for Drying Column
Please refer to service schedule for suitable quantity of service kits per compressor.
- 070904 Three Phase Parallel Connection Kit - Parallel connection of like-for-like compressor operation

ESAM600Q

QUIET OIL-FREE AIR COMPRESSOR

The ESAM600Q, quiet series tandem two cylinder compressor provides oil-free and quiet operation through its unique design. Our compressors are rigorously tested to consistently deliver consistent clean, dry, and hygienic air through 8-stage air treatment. Best of all these compressors only require minimal annual maintenance.

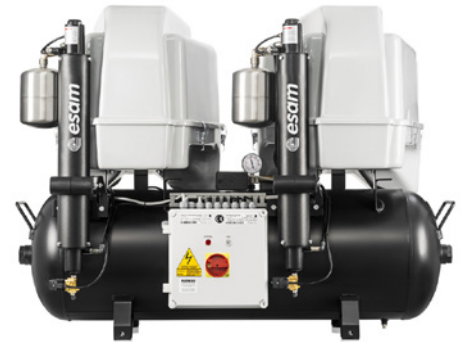

DETAILS THAT MATTER

- » Low-noise operation at 70.4dB(A)
- » 5-years compressor warranty
- » Certified food grade resin coated tank
- » Anti-microbial silver-ion tank lining
- » Motor protection switch to protect from overload



TECHNICAL DATA

ESAM600Q

Item Code	kW	Amp	Phases	Volt	Max. Air Flow at 5 Bar NI/min	Tank Size Litres	Cylinders	Sound dB(A)	Height	Width	Depth	Weight Kg
013557	3	7.4	3	400	476	150	Tandem 3	70.4	1040	1320	770	169

ACCESSORIES

- 168429 HEPA H14 Compressor Drying Column Filter 1-Pack
- 168563 Air Inlet Filter for Compressor Head Unit
- KSK3013B Minor Service Kit - 3 Cylinder Head Unit and HEPA H14 Filter for Drying Column
Please refer to service schedule for suitable quantity of service kits per compressor.
- 070904 Three Phase Parallel Connection Kit - Parallel connection of like-for-like compressor operation

ESAM600QE

QUIET OIL-FREE AIR COMPRESSOR

The ESAM600QE, quiet series tandem three cylinder compressor provides oil-free and quiet operation through its unique design. The “E” models include a pre-filter on the drying column to remove excess moisture prior to entering system aiding in the deliver consistent clean, dry, and hygienic air. This is especially in areas where there is high-humidity.



DETAILS THAT MATTER

- » Low-noise operation at 70.4dB(A)
- » 5-years compressor warranty
- » Certified food grade resin coated tank
- » Anti-microbial silver-ion tank lining
- » Motor protection switch to protect from overload



TECHNICAL DATA

ESAM600QE

Item Code	kW	Amp	Phases	Volt	Max. Air Flow at 5 Bar NL/min	Tank Size Litres	Cylinders	Sound dB(A)	Height	Width	Depth	Weight Kg
013557E	3	7.4	3	400	476	150	Tandem 3	70.4	1040	1320	770	170.2

ACCESSORIES

168429	HEPA H14 Compressor Drying Column Filter 1-Pack
168563	Air Inlet Filter for Compressor Head Unit
KSK1013B	Minor Service Kit - 1 Cylinder Head Unit and HEPA H14 Filter for Drying Column
KSK101B	Intermediate Service Kit - 1 Cylinder Head Unit, 1PH Capacitor and HEPA H14 Filter for Drying Column
DRK2000	Single Phase Parallel Connection Kit - Parallel connection of like-for-like compressor operation

8-BAR COMPRESSORS

HYGIENIC AND DRY AIR

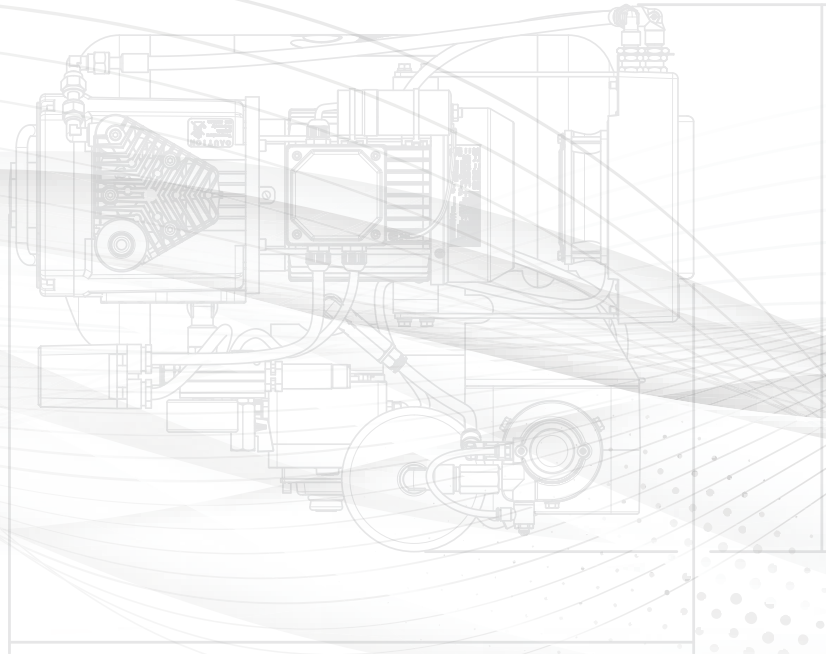

ESAM's 8-Bar Compressors command the industrial forefront with competitive vigour. Engineered for high-stakes environments needing substantial pressure—such as heavy-duty manufacturing and pivotal healthcare processes—they ensure hygienic, oil-free, and dry air delivery. These powerhouses encapsulate ESAM's 40-year journey of world-class quality and durability. They don't just perform, they set the pace for operational excellence and robust reliability in every task.

ESAM310

OIL-FREE AIR COMPRESSOR 8 BAR

The ESAM310 triple cylinder compressor provides oil-free operation through its unique design. Our compressors are rigorously tested to consistently deliver consistent clean, dry, and hygienic air through 8-stage air treatment. Best of all these compressors only require minimal annual maintenance.

DETAILS THAT MATTER

- » 8 Bar pressure
- » 5-years compressor warranty
- » Certified food grade resin coated tank
- » Anti-microbial silver-ion tank lining
- » Motor protection switch to protect from overload



TECHNICAL DATA

ESAM310

Item Code	kW	Amp	Phases	Volt	Max. Air Flow at 8 Bar NI/min	Continuous. Air Flow at 8 Bar NI/min	Tank Size Litres	Cylinders	Sound dB(A)	Height	Width	Depth	Weight Kg
013310	1.5	10.2	1	230	165	108	45	3	73.6	750	620	520	64

ACCESSORIES

168429	HEPA H14 Compressor Drying Column Filter 1-Pack
168563	Air Inlet Filter for Compressor Head Unit
KSK1013B	Minor Service Kit - 1 Cylinder Head Unit and HEPA H14 Filter for Drying Column
KSK101B	Intermediate Service Kit - 1 Cylinder Head Unit, 1PH Capacitor and HEPA H14 Filter for Drying Column
DRK2000	Single Phase Parallel Connection Kit - Parallel connection of like-for-like compressor operation

ESAM4101P

OIL-FREE AIR COMPRESSOR 8 BAR

The ESAM410 tandem two cylinder compressor provides oil-free operation through its unique design. Our compressors are rigorously tested to consistently deliver consistent clean, dry, and hygienic air through 8-stage air treatment. Best of all these compressors only require minimal annual maintenance.



DETAILS THAT MATTER

- » 8 Bar pressure
- » 5-years compressor warranty
- » Certified food grade resin coated tank
- » Anti-microbial silver-ion tank lining
- » Single Phase electrical connection
- » Motor protection switch to protect from overload



TECHNICAL DATA

ESAM4101P

Item Code	kW	Amp	Phases	Volt	Max. Air Flow at 8 Bar NI/min	Continuous Air Flow at 8 Bar NI/min	Tank Size Litres	Cylinders	Sound dB(A)	Height	Width	Depth	Weight Kg
013410	2.4	15.4	1	230	215	140	100	Tandem 2	73	745	1155	550	112

ACCESSORIES

168429	HEPA H14 Compressor Drying Column Filter 1-Pack
168563	Air Inlet Filter for Compressor Head Unit
KSK1013B	Minor Service Kit - 1 Cylinder Head Unit and HEPA H14 Filter for Drying Column
KSK101B	Intermediate Service Kit - 1 Cylinder Head Unit, 1PH Capacitor and HEPA H14 Filter for Drying Column
DRK2000	Single Phase Parallel Connection Kit - Parallel connection of like-for-like compressor operation

ESAM410

OIL-FREE AIR COMPRESSOR 8 BAR

The ESAM410 tandem two cylinder compressor provides oil-free operation through its unique design. Our compressors are rigorously tested to consistently deliver consistent clean, dry, and hygienic air through 8-stage air treatment. Best of all these compressors only require minimal annual maintenance.



DETAILS THAT MATTER

- » 8 Bar pressure
- » 5-years compressor warranty
- » Certified food grade resin coated tank
- » Anti-microbial silver-ion tank lining
- » Motor protection switch to protect from overload



TECHNICAL DATA

ESAM410

Item Code	kW	Amp	Phases	Volt	Max. Air Flow at 8 Bar NI/min	Continuous Air Flow at 8 Bar NI/min	Tank Size Litres	Cylinders	Sound dB(A)	Height	Width	Depth	Weight Kg
013413	3	7.2	3	400	215	140	100	Tandem 2	73	745	1155	550	112

AIR COMPRESSORS

ACCESSORIES

- 168429 HEPA H14 Compressor Drying Column Filter 1-Pack
- 168563 Air Inlet Filter for Compressor Head Unit
- KSK2013B Minor Service Kit - 2 Cylinder Head Unit and HEPA H14 Filter for Drying Column
Please refer to service schedule for suitable quantity of service kits per compressor.
- 070904 Three Phase Parallel Connection Kit - Parallel connection of like-for-like compressor operation

ESAM610

OIL-FREE AIR COMPRESSOR 8 BAR

The ESAM610 tandem three cylinder compressor provides oil-free operation through its unique design. Our compressors are rigorously tested to consistently deliver consistent clean, dry, and hygienic air through 8-stage air treatment. Best of all these compressors only require minimal annual maintenance.



DETAILS THAT MATTER

- » 8 Bar pressure
- » 5-years compressor warranty
- » Certified food grade resin coated tank
- » Anti-microbial silver-ion tank lining
- » Motor protection switch to protect from overload



TECHNICAL DATA

ESAM610

Item Code	kW	Amp	Phases	Volt	Max. Air Flow at 8 Bar NI/min	Continuous Air Flow at 8 Bar NI/min	Tank Size Litres	Cylinders	Sound dB(A)	Height	Width	Depth	Weight Kg
013513	3	7.4	3	400	330	217	150	Tandem 3	74	890	1320	590	137

ACCESSORIES

- 168429 HEPA H14 Compressor Drying Column Filter 1-Pack
- 168563 Air Inlet Filter for Compressor Head Unit
- KSK3013B Minor Service Kit - 3 Cylinder Head Unit and HEPA H14 Filter for Drying Column
Please refer to service schedule for suitable quantity of service kits per compressor.
- 070904 Three Phase Parallel Connection Kit - Parallel connection of like-for-like compressor operation

ESAM910

OIL-FREE AIR COMPRESSOR 8 BAR

The ESAM910 triple three cylinder compressor provides oil-free operation through its unique design. Our compressors are rigorously tested to consistently deliver consistent clean, dry, and hygienic air through 8-stage air treatment. Best of all these compressors only require minimal annual maintenance.



DETAILS THAT MATTER

- » 8 Bar pressure
- » 5-years compressor warranty
- » Certified food grade resin coated tank
- » Anti-microbial silver-ion tank lining
- » Motor protection switch to protect from overload



TECHNICAL DATA

ESAM910

Item Code	kW	Amp	Phases	Volt	Max. Air Flow at 8 Bar NI/min	Continuous. Air Flow at 8 Bar NI/min	Tank Size Litres	Cylinders	Sound dB(A)	Height	Width	Depth	Weight Kg
013578	4.5	11.1	3	400	495	326	300	Triple 3	75	1000	1800	810	260

AIR COMPRESSORS

ACCESSORIES

- 168429 HEPA H14 Compressor Drying Column Filter 1-Pack
- 168563 Air Inlet Filter for Compressor Head Unit
- KSK3013B Minor Service Kit - 3 Cylinder Head Unit and HEPA H14 Filter for Drying Column
Please refer to service schedule for suitable quantity of service kits per compressor.
- 070904 Three Phase Parallel Connection Kit - Parallel connection of like-for-like compressor operation

QUIET 8 BAR COMPRESSORS

HYGIENIC AND DRY AIR

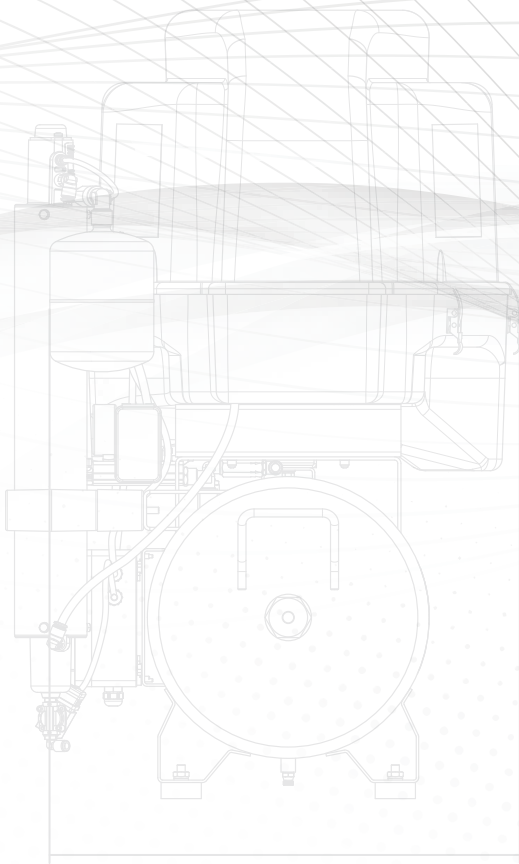

The Quiet 8-Bar Compressors from ESAM harmonise performance with subdued sound. Designed for operations requiring higher pressures, like advanced manufacturing and critical medical applications, they deliver maximum efficiency with minimal sound. These units stand as monuments to ESAM's relentless pursuit of innovation, offering low-noise operation without sacrificing strength. With a commitment to excellence woven through our history, they redefine the standards of industrial air technology performance.

ESAM310Q

QUIET OIL-FREE AIR COMPRESSOR 8 BAR

The ESAM310Q, quiet series three cylinder compressor provides oil-free and quiet operation through its unique design. Our compressors are rigorously tested to consistently deliver consistent clean, dry, and hygienic air through 8-stage air treatment. Best of all these compressors only require minimal annual maintenance.

DETAILS THAT MATTER

- » Low-noise operation at 68dB(A)
- » 5-years compressor warranty
- » Certified food grade resin coated tank
- » Anti-microbial silver-ion tank lining
- » 8 Bar pressure
- » Motor protection switch to protect from overload



TECHNICAL DATA

ESAM310Q

Item Code	kW	Amp	Phases	Volt	Max. Air Flow at 8 Bar NI/min	Continuous Air Flow at 8 Bar NI/min	Tank Size Litres	Cylinders	Sound dB(A)	Height	Width	Depth	Weight Kg
013355	1.5	10.2	1	230	165	108	45	3	68	979	720	700	80

ACCESSORIES

168429	HEPA H14 Compressor Drying Column Filter 1-Pack
168563	Air Inlet Filter for Compressor Head Unit
KSK1013B	Minor Service Kit - 1 Cylinder Head Unit and HEPA H14 Filter for Drying Column
KSK101B	Intermediate Service Kit - 1 Cylinder Head Unit, 1PH Capacitor and HEPA H14 Filter for Drying Column
DRK2000	Single Phase Parallel Connection Kit - Parallel connection of like-for-like compressor operation

ESAM410Q1P

QUIET OIL-FREE AIR COMPRESSOR 8 BAR

The ESAM410Q1P, quiet series tandem two cylinder compressor provides oil-free and quiet operation through its unique design. Our compressors are rigorously tested to consistently deliver consistent clean, dry, and hygienic air through 8-stage air treatment. Best of all these compressors only require minimal annual maintenance.



DETAILS THAT MATTER

- » Low-noise operation at 63.8dB(A)
- » 5-years compressor warranty
- » Certified food grade resin coated tank
- » Anti-microbial silver-ion tank lining
- » 8 Bar pressure
- » Motor protection switch to protect from overload



TECHNICAL DATA

ESAM410Q1P

Item Code	kW	Amp	Phases	Volt	Max. Air Flow at 8 Bar NI/min	Continuous Air Flow at 8 Bar NI/min	Tank Size Litres	Cylinders	Sound dB(A)	Height	Width	Depth	Weight Kg
013455	2.4	15.4	1	230	215	140	100	Tandem 2	63.8	890	1160	650	135

ACCESSORIES

168429	HEPA H14 Compressor Drying Column Filter 1-Pack
168563	Air Inlet Filter for Compressor Head Unit
KSK2013B	Minor Service Kit - 2 Cylinder Head Unit and HEPA H14 Filter for Drying Column
KSK201B	Intermediate Service Kit - 2 Cylinder Head Unit, 1PH Capacitor and HEPA H14 Filter for Drying Column
DRK2000	Single Phase Parallel Connection Kit - Parallel connection of like-for-like compressor operation

ESAM410Q

QUIET OIL-FREE AIR COMPRESSOR 8 BAR

The ESAM410Q, quiet series tandem two cylinder compressor provides oil-free and quiet operation through its unique design. Our compressors are rigorously tested to consistently deliver consistent clean, dry, and hygienic air through 8-stage air treatment. Best of all these compressors only require minimal annual maintenance.



DETAILS THAT MATTER

- » Low-noise operation at 63.8dB(A)
- » 5-years compressor warranty
- » Certified food grade resin coated tank
- » Anti-microbial silver-ion tank lining
- » 8 Bar pressure
- » Motor protection switch to protect from overload



TECHNICAL DATA

ESAM410Q

Item Code	kW	Amp	Phases	Volt	Max. Air Flow at 8 Bar NI/min	Continuous. Air Flow at 8 Bar NI/min	Tank Size Litres	Cylinders	Sound dB(A)	Height	Width	Depth	Weight Kg
013458	3	7.4	3	400	215	140	100	Tandem 2	63.8	890	1160	650	135

AIR COMPRESSORS

ACCESSORIES

- 168429 HEPA H14 Compressor Drying Column Filter 1-Pack
- 168563 Air Inlet Filter for Compressor Head Unit
- KSK2013B Minor Service Kit - 2 Cylinder Head Unit and HEPA H14 Filter for Drying Column
Please refer to service schedule for suitable quantity of service kits per compressor.
- 070904 Three Phase Parallel Connection Kit - Parallel connection of like-for-like compressor operation

ESAM610Q

QUIET OIL-FREE AIR COMPRESSOR 8 BAR

The ESAM610Q, quiet series tandem three cylinder compressor provides oil-free and quiet operation through its unique design. Our compressors are rigorously tested to consistently deliver consistent clean, dry, and hygienic air through 8-stage air treatment. Best of all these compressors only require minimal annual maintenance.

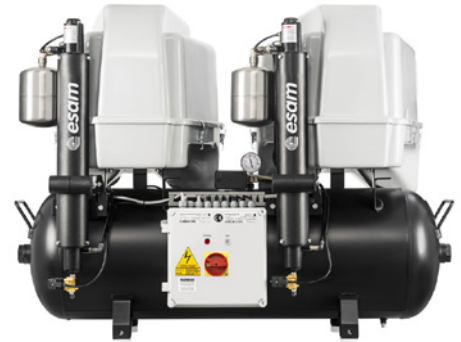

DETAILS THAT MATTER

- » Low-noise operation at 70.4 dB(A)
- » 5-years compressor warranty
- » Certified food grade resin coated tank
- » Anti-microbial silver-ion tank lining
- » 8 Bar pressure
- » Motor protection switch to protect from overload



TECHNICAL DATA

ESAM610Q

Item Code	kW	Amp	Phases	Volt	Max. Air Flow at 8 Bar NI/min	Continuous Air Flow at 8 Bar NI/min	Tank Size Litres	Cylinders	Sound dB(A)	Height	Width	Depth	Weight Kg
013558	3	7.4	3	400	330	217	150	Tandem 3	70.4	1040	1320	770	169

ACCESSORIES

168429	HEPA H14 Compressor Drying Column Filter 1-Pack
168563	Air Inlet Filter for Compressor Head Unit
KSK3013B	Minor Service Kit - 3 Cylinder Head Unit and HEPA H14 Filter for Drying Column
Please refer to service schedule for suitable quantity of service kits per compressor.	
070904	Three Phase Parallel Connection Kit - Parallel connection of like-for-like compressor operation

ACCESSORIES

OIL-FREE COMPRESSORS

Our premium ESAM compressors are supported by a comprehensive range of accessories to provide reliable performance. Our specially designed accessories including parallel kits give your compressors even more flexibility to grow with your business.

Each and every accessory has been tested to ensure compatibility with our compressors and meet our “QUALITY COMES FIRST” commitment.

ACOUSTIC CABINET

Need to reduce noise? The ESAM Acoustic Cabinet is designed to house the ESAM100, ESAM200 and ESAM300 compressors. Made from an electro galvanised metal plate and epoxy-polyester powders that withstand the elements it provides the perfect solution for indoor or outdoor installation when noise has to be mitigated.

Reduces sound of compressors:

- » ESAM100 = 50 dB(A)
- » ESAM200 = 51 dB(A)
- » ESAM300 = 51 dB(A)

DETAILS THAT MATTER

- » Inbuilt fan to ventilate compressor
- » Weather resistant
- » Indoor or outdoor installation



ACOUSTIC CABINET

Item Code	Name	Product Suitability	Height	Width	Depth	Weight
010800	Acoustic Cabinet	<ul style="list-style-type: none"> • ESAM100 • ESAM200 • ESAM300 	887 mm	870 mm	700 mm	84 kg

HEPA H14 FILTER - DRYING COLUMN

Positioned on the top of the drying column the HEPA H14 filter removes 99.975% of all particles down to 0.3 micron.

DETAILS THAT MATTER

- » High Efficiency Particulate Filter
- » Annual replacement recommended
- » Easy to replace



HEPA FILTER & O-RING - DRYING COLUMN

Item Code	Name	Product Suitability	Height	Width	Depth	Weight
168429-1	HEPA H14 Filter and O-ring	<ul style="list-style-type: none"> • All compressors 				

INLET FILTER - HEAD UNIT

Compressor head filter protects the head unit from dust and particles down to 20 micron.

DETAILS THAT MATTER

- » Annual replacement recommended
- » Easy to replace



INLET FILTER - COMPRESSOR HEAD UNIT

Item Code	Name	Product Suitability	Height	Width	Depth	Weight
168563	Inlet Filter	<ul style="list-style-type: none"> • All compressors 				

PRE-FILTER DRYING COLUMN

The Pre-filter for the desiccant dryer removes additional condensation from the air prior to entering the drying column. Commonly used in regions where higher humidity is present. One Pre-filter is fitted per drying column.



DETAILS THAT MATTER

- » Ideal for humid environments
- » Easily retrofitted

PRE-FILTER - COMPRESSOR

Item Code	Name	Product Suitability	Height	Width	Depth	Weight
KE10000	Pre-Filter Kit	<ul style="list-style-type: none"> • All compressors with desiccant dryer 				

COMPRESSOR SERVICE KITS

“QUALITY COMES FIRST” is our mantra at ESAM. To support this we have Service Kits for routine maintenance of our compressors to help ensure reliability.



DETAILS THAT MATTER

- » Everything required is in the one pack.
- » Easy routine maintenance

ANNUAL SERVICE KIT

Item Code	Name	Product Suitability
KSK1013B	1 Cylinder Service Kit: <ul style="list-style-type: none"> • Includes Inlet Filter, HEPA H14 Filter and O-ring. 	<ul style="list-style-type: none"> • Single Cylinder Compressors
KSK2013B	2 Cylinder Service Kit: <ul style="list-style-type: none"> • Includes Inlet Filters, HEPA H14 Filter and O-ring. 	<ul style="list-style-type: none"> • Two Cylinder Compressors
KSK3013B	3 Cylinder Service Kit: <ul style="list-style-type: none"> • Includes Inlet Filters, HEPA H14 Filter and O-ring. 	<ul style="list-style-type: none"> • Three Cylinder Compressors
KSK010611B	6 Cylinder Service Kit: <ul style="list-style-type: none"> • Includes Inlet Filters, HEPA H14 Filter and O-ring. 	<ul style="list-style-type: none"> • Six Cylinder Compressors

YEAR 3 SERVICE KIT (SINGLE PHASE COMPRESSORS ONLY)

Item Code	Name	Product Suitability
KSK101B	1 Cylinder Service Kit: <ul style="list-style-type: none"> • Includes Motor Start Capacitor, Inlet Filter, HEPA H14 Filter and O-ring. 	<ul style="list-style-type: none"> • Single Cylinder Compressors
KSK201B	2 Cylinder Service Kit: <ul style="list-style-type: none"> • Includes Motor Start Capacitor, Inlet Filters, HEPA H14 Filter and O-ring. 	<ul style="list-style-type: none"> • Two Cylinder Compressors
KSK301B	3 Cylinder Service Kit: <ul style="list-style-type: none"> • Includes Motor Start Capacitor, Inlet Filters, HEPA H14 Filter and O-ring. 	<ul style="list-style-type: none"> • Three Cylinder Compressors

APPENDIX

SIDE CHANNEL BLOWERS THREE PHASE SPECIAL ORDER RANGE

+ Indent Only ‡ POA/INDENT ● Two Stage Blower - Greater Pressure ● Two Stage Blower - Greater Volume

TECHNICAL DATA														
Item Code	kW	Δ Delta Volt	Δ Delta Amp	Y Star Volt	Y Star Amp	Max. Air Flow m³/hr*	Max. Pressure mBar*	Max. Vacuum mBar*	Sound dB(A)	Height	Width	Depth	Weight Kg	Inlet & Outlet
‡ 019165	0.75	230	3.4	400	1.95	80	+245	-270	64	251	245.5	489	16	1¼"
‡ 046766	0.75	200-240	4.7	345-415	2.7	135	+120	-120	68	251	245.5	302.5	18	1½"
‡ 046780	1.1	200-240	5.2	345-415	3	135	+155	-155	68	251	245.5	302.5	18	1½"
‡ 046950	1.5	200-240	7.1	345-415	4.1	135	+245	-245	65	319	302.5	543	25	1½"
‡ 048150	2.2	230	9	400	5.2	200	+265	-230	72	341	334	572	31	1½"
‡ 061735	2.2	200-240	10.5	345-415	6	330	+165	-185	76	415	395	357	32	2"
‡ 061732	2.55	200-240	11.2	345-415	6.5	330	+220	-215	76	415	395	357	32	2"
‡ 061750	2.2	230	9	400	5.2		+165	-175	76	415	395	332	30	2"
‡ 061751	3	230	11.8	400	6.8		+165	-235	76	415	395	357	32	2"
‡ 091621	5.5	200-240	22.5	345-415	13	330	+390	-320	77	415	395	732	57	2"
‡ 079550	4	200-240	16.7	345-415	9.7	500	+125	-145	78	522	456	433	85	2½"
‡ 080076	11	345-415	24.2	-	-	600	+400	-390	78	583.5	530	566	112	2½"
‡ 083027	7.5	345-415	17.8	-	-	1200	+100	-120	82	631	570	596	119	4"
‡ 083068	11	345-415	30.2	-	-		+195	-230	82	631	570	675	140	4"
‡ 083xxx	12.5	345-415	27	-	-		+190	-230	-	631	570	675	148	4"

IE3 OPTIONS - SIDE CHANNEL BLOWER

kW RATING | THREE PHASE

+ Indent Only † POA/INDENT ● Two Stage Blower - Greater Pressure ● Two Stage Blower - Greater Volume

3PH SIDE CHANNEL BLOWERS

kW	Item Code	Item Description	Δ Delta Volt	Δ Delta Amp	Y Star Volt	Y Star Amp	Max. Air Flow m³/hr*	Max. Pressure mBar*	Max. Vacuum mBar*	Indent Only
● 0.75	019181	UNI-JET 75 2V	230	3	400	1.75	80	190	-180	+
0.75	046681	TECNO-JET II/S VA	230	3.7	400	2.15	135	130	-125	+
0.9	046682	TECNO-JET II/S VP	230	3.45	400	2	135	155	-135	+
● 1.2	046645	TECNO-JET 2V	230	4.8	400	2.8	135	170	-175	+
1.3	047031	FLUX-JET 1.3	230	5.7	400	3.3	200	120	-135	+
1.5	047044	FLUX-JET 1.5	230	5.1	400	3	200	155	-165	+
2.2	061844	MEDIO-JET 2.2	230	7.4	400	4.3	330	150	-160	+
2.2	061843	MEDIO-JET 2.2	230	9	400	5.2	330	135	-150	+
3	061872	MEDIO-JET 3	230	11.4	400	6.6	330	220	-230	+
4	056511	UNI-JET 160	230	15.9	400	9.2	160	440	-345	+
4	061853	MEDIO-JET LHT 4	230	15.9	400	9.2	330	225	-255	+
4	061854	MEDIO-JET 350 LHT	230	15.9	400	9.2	370	245	-260	+
● 4	091774	MEDIO-JET 2V 4	230	15.9	400	9.2	330	260	-315	+
● 4	091862	MEDIO-JET 1AC 4	230	15.9	400	9.2	500	100	-135	+
● 5	091874	MEDIO-JET 1AC 5.5	230	21.4	400	12.4	500	200	-215	+
5	079551	UNI-JET 501 5	230	21.4	400	12.4	500	220	-225	+
● 5.5	091773	MEDIO-JET 2V 5.5	230	18.7	400	10.8	330	390	-320	+
● 5.5	091772	MEDIO-JET 2V LHT	230	18.7	400	10.8	330	420	-390	+
● 5.5	091771	MEDIO-JET 2V LHT	400	12.4	690	7.2	500	440	-390	+
● 5.5	091867	MEDIO-JET 1AC 5.5	230	18.7	400	10.8	500	195	-220	+
● 5.5	091863	MEDIO-JET 1AC 5.5	400	12.4	500	215	-225	220	-225	+
5.5	079554	UNI-JET 501	230	18.7	400	10.8	500	225	-240	+
6	079553	UNI-JET 501 6	230	22.7	400	13.1	500	155	-200	+
6	079556	UNI-JET 501 6	400	13.3	690	7.7	500	155	-200	+
6	080094	UNI-JET 500 6	400	13.3	600	100	-100	250	-250	+
6.3		UNI-JET 501 6.3	230	22.3	400	12.9	500	250	-250	+
7.5	080099	UNI-JET 500 7.5	230	27.2	400	15.7	600	210	-225	+
9	080101	UNI-JET 500 9	230	28.8	400	16.6	600	310	-320	+
12.5		UNI-JET 1000 12.5	400	24.55	690	14.2	1200	230	-235	+
15	083210	UNI-JET 1000 15	400	25.8	690	14.9	1200	260	-300	+
15	084042	UNI-JET 1500 15	400	25.8	690	14.9	1500	180	-210	+
18.5	083215	UNI-JET 1000 18.5	400	32.2	690	18.6	1200	350	-325	+
20	083216	UNI-JET 1000 20	400	34.2	690	19.8	1200	385	-340	+
20	084043	UNI-JET 1500 20	400	34.2	690	19.8	1500	290	-325	+
20	087003	UNI-JET 2200 20	400	34.2	690	19.8	2200	175	-205	+

*Tolerance +/-10%. air temperature 20°C

†Sound-pressure data in accordance to ISO 3746-1979 (E) norms. Parameters: r=1 - Background noise 51dB(A) - Instrument used : Brüel & Kjær.

USEFUL INFORMATION

HOW TO READ THE DATA LABEL SIDE CHANNEL BLOWERS

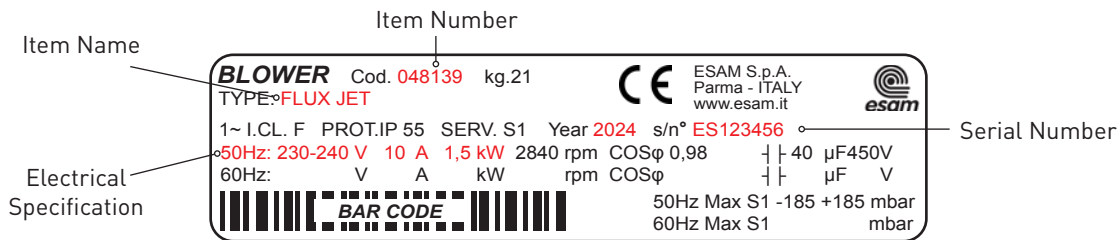

KEY TERMINOLOGY

Bar:

Bar is a metric unit of pressure that is commonly used to measure Atmospheric Pressure. One Bar is equal to the air pressure on the earth at sea level at 15°C.

Millibar (mbar):

Millibar (mbar) is a metric unit of air pressure, often used to measure the maximum pressure a unit can safely handle. One millibar equals one thousandth of a bar (1 mbar = 0.001 bar), or about 100 pascals.

Litres per Minute (L/min):

Litres per minute is the airflow output expressed in litres over a period of one minute.

Maximum Airflow:

The maximum volumetric flow rate a unit can achieve under specified operating conditions, including system pressure and environmental factors.

Continuous Airflow:

The constant, uninterrupted air volume a unit delivers under specified operating conditions, including system pressure and environmental factors.

Weighted Decibels (dB(A)):

Sound pressure measurement weighted to give an approximate of how a human ear hears sound.



ESAM Australia Pty Ltd

5 Sheppard Street
Thornbury
Victoria 3071
+61 3 9484 5719
esam@esam.com.au

ESAM has a policy of continuous improvement and innovation as such we reserve the right to alter specifications without notice. Whilst every care has been taken in the preparation of this publication, ESAM does not warrant the completeness or accuracy of the information provided and to the extent permitted by law, ESAM Australia excludes all liability, including negligence, for any loss incurred in reliance on the contents of this publication. Please refer to the website for the most current product specifications. Product images and packaging are for illustrative purposes only, variations can occur due to the printing process of colours therefore the product you receive may not exactly correspond to the image.